

# ROPE SPLICING

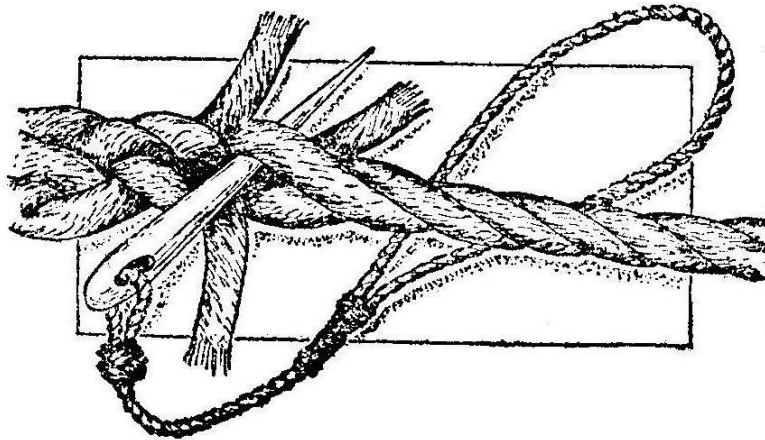

By P. W. BLANFORD

Assistant County Commissioner Sea Scouts, Warwickshire  
4/6 net

Leader — National Scout Canoe Cruises

Author of Scout Mapping, Netmaking, Scouting on the Water, Canoeing etc.

*First Printed 1950*

*Revised — 1953*

---

*Original Printed and Made in Great Britain by*  
BROWN, SON & FERGUSON LIMITED, GLASGOW



This electronic edition

©2006 Canadian Sea Scouts Homeport - <http://www.seascouts.ca/>

Prepared by Petr (Gord) Staša and Karl Pollak.

Editor's Notes:

The reader is reminded that these texts have been written a long time ago. Consequently, they may use some terms or express sentiments which were current at the time, regardless of what we may think of them at the beginning of the 21st century. For reasons of historical accuracy they have been preserved in their original form.

If you find them offensive, we ask you to please delete this file from your system.

This book was written in England and thus contains English spelling and English terms.

For more historical texts with traditional Scouting topics, visit the The Dump at:

<http://www.thedump.scoutscan.com/>



## PREFACE

This book is an attempt to gather descriptions of all kinds of rope splices into one volume. While there are many excellent books on knotting and general ropework, which include splicing in their contents, it was felt that there was a need for a book devoted solely to splicing, in which the subject could be given much fuller treatment. Only sufficient knotting and other supplementary information is included to make the descriptions self-contained. For information on knotting the reader is recommended to *Knots and Splices* by Capt. Jutsum, for fancy work to *Knots, Splices and Fancy Work* by C. L. Spencer, and for wire splicing to *Marline-Spike Seamanship* by Leonard Popple.

Many splices have had more than one name and sometimes the same name has been given to more than one splice. No doubt, the originators were more concerned with uses than names. In this book those names which seem to be most commonly applied are used.

It is believed that the reader will find a greater number of splices described in this book (some for the first time) than he will in any other. There are probably many others which have never been committed to paper, and the author would appreciate it if anyone knowing of any other splices would send details to him, c/o the Publishers, so that any future edition can be made even more comprehensive.

Finally, thanks are due to W. J. Martin Tomson for his keen co-operation and research in connection with some of the less common splices.

# CONTENTS

CHAPTER 1.	
PRINCIPLES OF SPLICING.	
Kinds of rope – Tools – Tucking – Tapering – Strength – Dog knots .....	5
CHAPTER 2.	
THE BASIC SPLICES.	
Back splice – Eye splice – Short splice — Long splice.....	7
CHAPTER 3.	
VARIATIONS ON THE EYE SPLICE.	
Branch splice–Cut splice – Long line splice – Eye in middle of rope – Sailmaker’s splice –Eye splice, wormed and collared– Eye splice with single collar– Eye splice, grafted – German eye splice .....	11
CHAPTER 4.	
SPECIAL EYES.	
Flemish eye – Grommet splice – Chain splice .....	16
CHAPTER 5.	
END TO END SPLICES.	
Shroud knots – Short splice (3-strand into 4-strand) – Long splice (3-strand into 4-strand) – Short splice, knotted – Short splice (rope to wire)–Long splice (rope to wire) – Grecian splice .....	19
CHAPTER 6.	
SPLICING CABLES AND BRAIDED ROPE.	
Ropemaker's eye – Admiral Elliot's eye – Common eye splice (cable) – Short splice (cable) – Long splice (cable) – Staggered short splice (cable) – Eye splice (braided rope) – Short splice (braided rope) – Back splice (braided rope) .....	26
CHAPTER 7.	
MISCELLANEOUS SPLICES.	
Cringle to sail – Cringle to rope Grommet – Selvage strop – Flag rope – Pudding splice Guy line eye – Cockscombing .....	33

# ROPE SPLICING

## CHAPTER 1.

### PRINCIPLES OF SPLICING.

The dictionary definition of splicing as "to join by interweaving strands" is correct, if not very expansive. Splicing differs from knotting in that the parts of the rope are worked separately instead of using the rope as a whole. There are a few knots, mostly ornamental, in which the strands are used. These are borderline cases, but in general the definition of the difference between splicing and knotting is true. A splice also makes a more permanent fastening than a knot.

Most rope is three-stranded and usually laid up right-handed (i.e. if you look along the rope, the strands spiral away from you in a clockwise direction). This is called "hawser-laid rope". Other rope has four strands (with a fifth "heart" strand in all but the smallest sizes). This is called "shroud-laid rope". Larger "cable-laid" ropes are composed of three right-handed hawser-laid ropes laid up together left-handed, making a total of nine strands. It is not the purpose of this book to discuss ropemaking, but, so that the reader will understand the terms used, the names of the various parts of a rope are shown in Fig. 1.

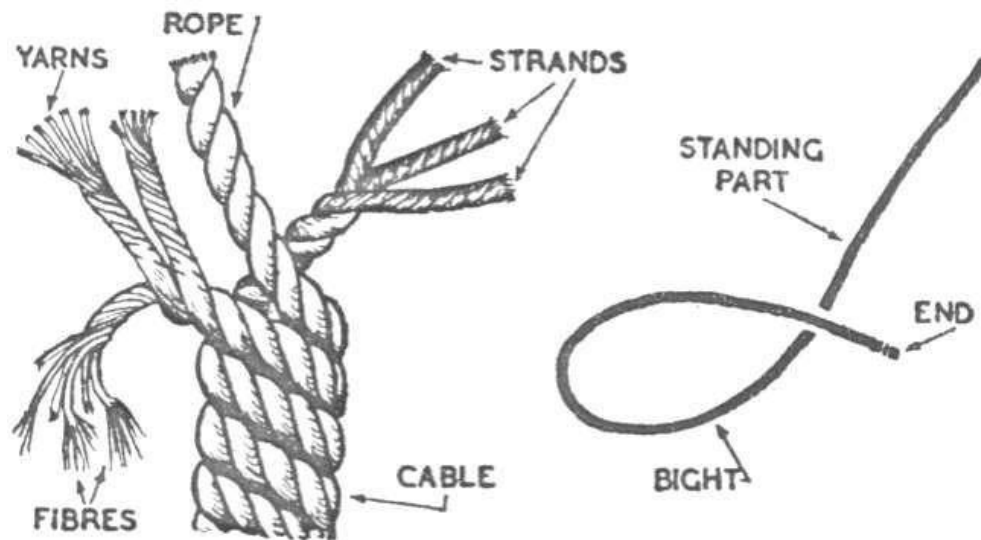

*Fig. 1. – The parts of a rope.*

The tools needed for rope splicing are few, merely a knife for cutting, and some sort of a spike for opening the strands of the rope. For small ropes a steel marline spike is useful, while for bigger stuff a wooden spike called a "fid" is best. In all cases the taper of the spike should be straight, right back from the point to the opposite end.

Ropes are made of a number of materials including hemp, manila, flax, sisal, coir and cotton. Hemp and manila strands keep their shape when opened out, making them suitable for practice splices. The synthetic material, nylon, is also made into ropes, but because of its slippery nature a greater number of tucks should be used – five where three is usual in other materials.

While stiff rope must be forced and held open with a spike, soft and well-worked rope can usually be opened by twisting it against the lay. The hole may be held open by pushing the thumb into it. If there is room it is better to fold the end of the strand being tucked back on itself, so that a small bight is to be pushed through and there is less risk of fraying the end of the strand. Alternatively, with a loosely-formed rope such as cotton, the end of each strand should be whipped.

In a properly formed splice, the interwoven strands should lie almost at right-angles to each other. This can only be achieved if, after each tuck, the strands in turn, are jerked back away from the standing part.

In most splices the joint is made secure by the interweaving of the strands “against the lay”, each going “over and under one” alternately. In a few splices the strands are tucked “with the lay”, each strand working back around the strand it is first tucked under. When each strand has been tucked once, one “tuck” is said to be completed. The number of tucks needed to make a secure splice is a matter on which there are varying opinions. For most purposes it can be assumed that three tucks with the strands of their full thickness will be satisfactory. For the sake of appearance one third of the fibres in each strand may be scraped away after the third tuck and the strands tucked again. Then a further third is scraped away and one more tuck made before the ends are cut off. These are known as taper tucks, and will be referred to in this way elsewhere in this book. The splice just described would be said to have three whole and two taper tucks.

Where neatness is more important than strength, as in fancy work, it may be sufficient to give only one whole tuck then two or three taper tucks. There will be a slight increase in strength if more than three whole tucks are used.

A completed splice may be rolled into shape under the foot or between two boards. If it has many “whiskers” they may be singed off with a match or taper. For most purposes the splice may be considered finished after the last tuck has been made and the ends cut off. To guard against the risk of the ends becoming untucked, and to improve the appearance of the splice, a seizing may be put around the last tuck.

No splice can be as strong as the rope of which it is made. However, a well-made splice is stronger than a knot for instance, an eye splice made with three whole and two taper tucks has a strength of about 90 per cent while a bowline has a strength of about 80 per cent that of the rope. Where the utmost strength is required and appearance is of secondary importance, a splice should be made with six or seven whole tucks, then the ends “dog-knotted” together, i.e., the yarns of each strand separated into two equal groups and each half-strand seized to its neighbour either with a separate strand, put on as a whipping; or with yarns from the half strands, if these are long enough.

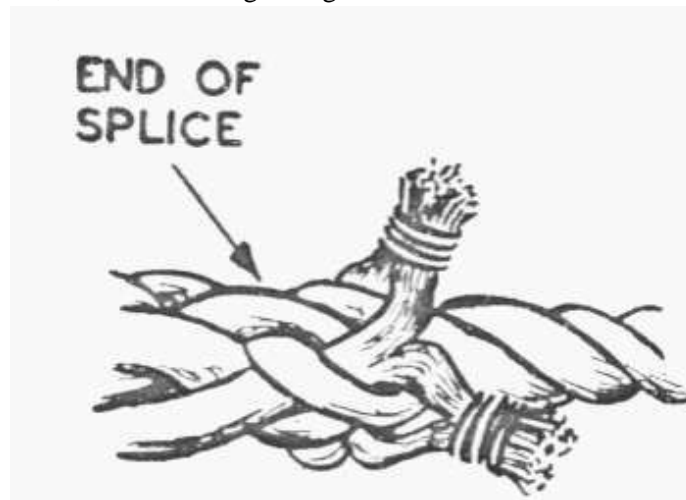

*Fig. 2. – Dog knots.*

If the latter method is used, the West Country whipping is most satisfactory – take a good yarn from each half strand and pass these yarns around the pair of half strands in opposite directions and make an overhand knot each time they meet.

## CHAPTER 2.

### THE BASIC SPLICES .

There are four common splices: back, eye, short and long. These are most frequently used and they form the basis of many of the other splices.

**Back Splice.** – This is the simplest splice (Fig. 3). It is a means of preventing the end of a rope fraying, and can be used instead of a whipping in circumstances where its increased thickness will not be a disadvantage, e.g., where the rope's end does not have to pass through a block.

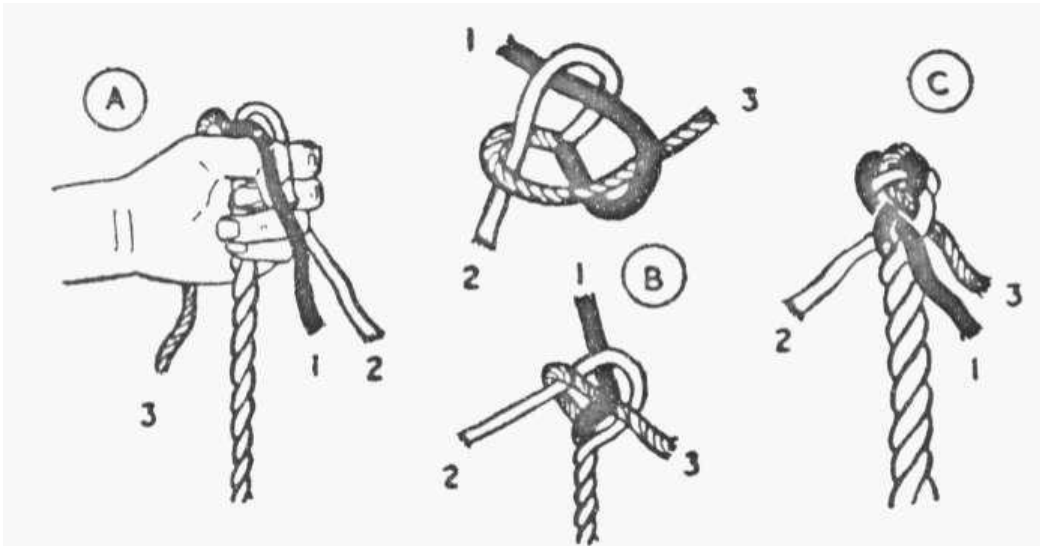

*Fig. 3. – A back splice.*

Start by making a crown knot in the following way: – Unlay the strands for a short distance (about 6 times the rope's circumference), and hold the rope in the left hand, letting the three strands hang evenly-spaced over the fist (A). Nest, working around the same way as the lay of the rope, take each strand in turn over the next one – 1 over 3, 2 over 3, and 3 down through the loop of 1(B). Pull tight and the result should show the crown flat on top and the ends lying across the strands of the rope approximately at right-angles to them.

Using a spike to lift the strands, take each end strand in turn over the strand it is resting against and under the next (C). Continue tucking each strand in turn, making a total of three whole tucks and two taper tucks.

Four-stranded rope is treated in the same way, the only difference being in the extra turn in the crown knot.

**Eye Splice.** – This is by far the most frequently used splice. It may be used to form an eye of any size or to enclose a toggle or thimble.

To make an eye splice in three-stranded rope (Fig. 4) unlay the strands for a short distance and bend the rope to form the eye, placing two end strands across at right-angles to the lay of the standing part of the rope, and the other strand behind (A). Take the centre strand under the nearest strand of the standing part (B). Take the first end strand under the next strand, going in where the second strand comes out (C). Turn the rope over and tuck the third strand under the remaining strand of the standing part, going in where the first strand comes out (D). There should now be an end strand projecting from each space of the standing part (E). This completes the first tuck.

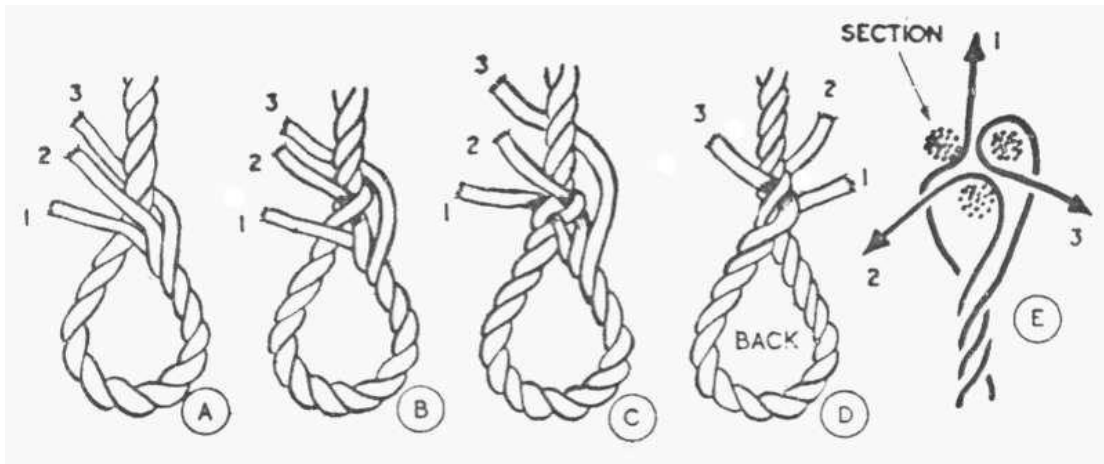

Fig. 4 – An eye splice in three stranded rope.

Tuck each strand in turn "over and under one", making three full tucks and two taper tucks.

To make an eye splice in four-stranded rope (Fig. 5), start as for the three-stranded splice, but lay three end strands on top and one under neath (A). Tuck strand 3 under the most convenient strand of the standing part, then take strand 2 in where 3 comes out and under the next one. Tuck strand 1 in the same space as 2, but go under two strands. Turn the rope over and tuck the fourth strand under the remaining strand of the standing part, going in where strand 1 comes out (B). It will be seen that strands 2, 3 and 4 are tucked in the same way as strands 1, 2 and 3 in a three-stranded rope splice. From this point proceed as for a three-stranded splice, making three whole and two taper tucks.

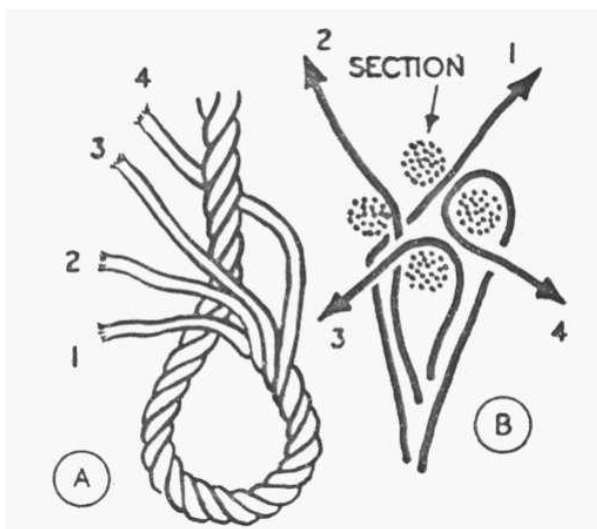
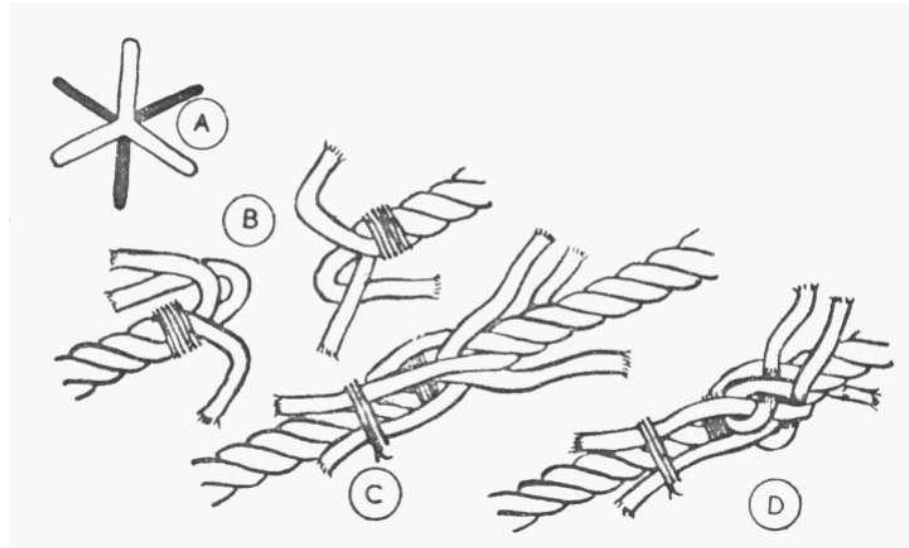

Fig. 5. – An eye splice in four stranded rope

**Short Splice.** – This splice (Fig. 6) is used for joining ropes end to end, when the extra thickness will not matter. If the rope has to pass through a block, this splice is unsuitable and a long splice must be used.

To make a short splice, unlay the strands of each rope for a distance of about 6 or 7 times the circumference of the rope. For a first attempt it is as well to whip them at the point of unlaying (B), but this will not be necessary after some experience has been gained. "Marry" the strands, i.e., bring the ends together so that the separated strands fit into each other, one strand being in the space between two strands of the opposite rope (A). Force the ropes tightly together and, if they have been whipped, seize the strands of one down to the other and cut off its whipping (C). If whippings are not being used, put a seizing over the junction of the two ropes.



*Fig. 6. – A short splice.*

Tuck each free strand over and under a strand of the other rope, working against (i.e. across) the lay (D). Make two whole tucks in this way, then remove the seizing, and the remaining whipping, and repeat the process with the other half of the splice. Two full tucks each way are sufficiently strong for most purposes. Taper tucks can be added for neatness.

**Long Splice.** – This splice (Fig. 7) uses up very much more of the rope than does a short splice, but it has the advantages of not increasing the thickness of the rope and it is hardly distinguishable from the ordinary rope. The amount of each rope to be unlayed varies according to the degree of strength required. For three-stranded rope, the minimum amount unlayed should be 7 times the circumference, and for four-stranded rope 10 times the circumference. The greater the amount unlayed, within reason, the stronger will be the splice. 12 to 14 times the circumference, as in the example, is satisfactory for three-stranded rope and half\_ as much again for four-stranded rope.

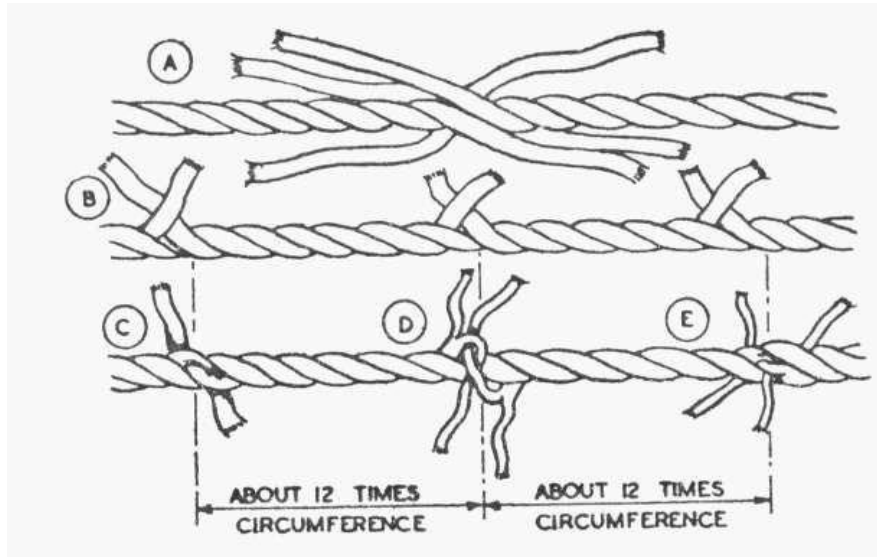

Fig. 7.—A long splice.

To make a long splice in three-stranded rope, unlay the ends of both ropes for a distance of about 12 to 14 times the circumference, then "marry" them as for a short splice (A). Without disturbing the other strands, select one strand and commence to unlay it, filling up the space it leaves with the corresponding strand of the other rope, working to within a few inches of its end. Do the same with another pair of strands, working the opposite way (B). Let the remaining pair of strands stay put.

The ends of the strands now have to be locked in some way, and a variety of methods are possible, among them are the following:

- (i) Tuck each end under its adjoining strand, then take it around and under the same strand three times, tapering well for the last two tucks.
- (ii) Divide the yarns in each strand into two equal groups. Tuck each half-strand around a separate main strand: take one half under and around the adjoining strand and the other half over the adjoining strand and under and around the next one.
- (iii) Half-knot the two ends together (C), then tuck as in a short splice, tapering well after the first tuck.
- (iv) Divide the yarns in each strand into two equal groups. Half-knot two of the half-strands together (D). Tuck the other half-strands under the adjoining main strands (F.) and continue, after tapering, tucking it around that strand. Taper the knotted half-strands, take them over the adjoining strands and under and around the next strands.

A long splice in four-stranded rope is made in a very similar way, but the amount of each rope to be unlayed has to be increased by a half – a good average length being eighteen times the circumference of the ropes. Marry the ropes and unlay one strand, filling its space with the corresponding strand of the other rope, to within a few inches of its end. Do the same with another pair in the opposite direction. Take one of the remaining central pairs and unlay one and lay up the other strand, working for only a short distance in one direction. Do the same in the other direction with the remaining pair. Arrange the final positions of the last two pairs worked so that the four junctions of the strands are evenly spaced at about 12-circumference intervals.

A long splice should be well stretched and rolled before the ends of the strands are finally cut off. This allows the newly-laid strands to settle into place and avoids the risk of cutting off the ends too close.

## CHAPTER 3.

### VARIATIONS ON THE EYE SPLICE.

This chapter deals with a number of splices in which the method used is basically that of the common eye splice. Although the resulting form is not necessarily an eye, the method and sequence of tucks is very similar to the eye splice described in the last chapter. In the illustrations which follow, those parts enclosed in circles are made exactly as in the common eye splice.

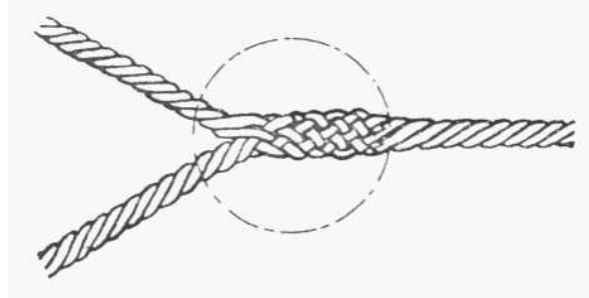

Fig. 8. – A branch splice.

Branch Splice. – This splice (Fig. 8) is used where one rope has to be joined into the middle of another rope, or a Y-formation is needed (e.g., a dual tow-rope) – the leg and one arm of the Y being continuous and the other arm joined in with a branch splice.

To make this splice, unlay the end strands of the branch rope and tuck them into the strands of the main rope, exactly as in the eye splice.

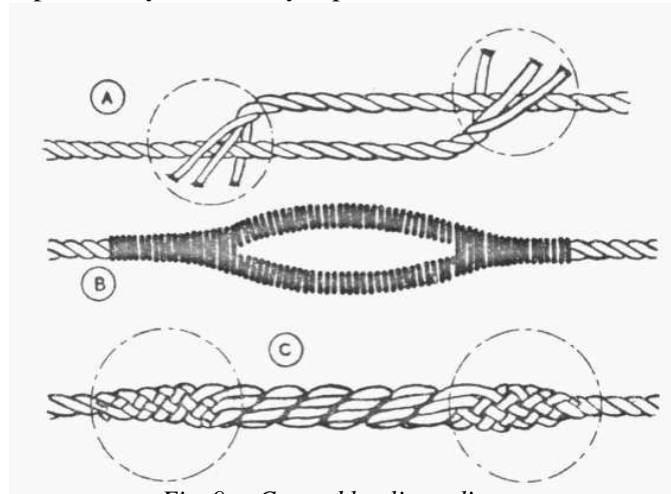

Fig. 9. – Cut and log line splices.

As this splice usually has to fit over a mast, peg, or similar object, it is best to protect the rope in – large sizes should be wormed, parcelled and served; or in small sizes, simply served all over (B).

Log Line Splice. – This splice (Fig. 9C) is a variation of the cut splice and may be used as an alternative to the short splice for joining ropes end to end.

Start as for a cut splice-make the tucks at one end, then twist the two ropes together in the opposite way to their lay, and make the tucks at the other end.

Cut Splice. – This type of splice (Fig. 9A and B) is useful for joining two ropes so as to leave a loop between them. The shrouds for a sailing dinghy's mast may be joined in this way and the loop slipped over the top of the mast. If the two sides of the loop are of unequal length, the splice is called a horseshoe splice.

To make a cut splice, unlay the end strands of both ropes, overlap the ends for the amount needed for the loop, then lay the end strands over the adjoining rope, in the same way as for starting an eye splice (A). Tuck each end three whole and two half tucks.

Eye in middle of rope. – This is an ordinary eye splice, except that instead of single strands, the tucks are made with twisted double strands (Fig. 10).

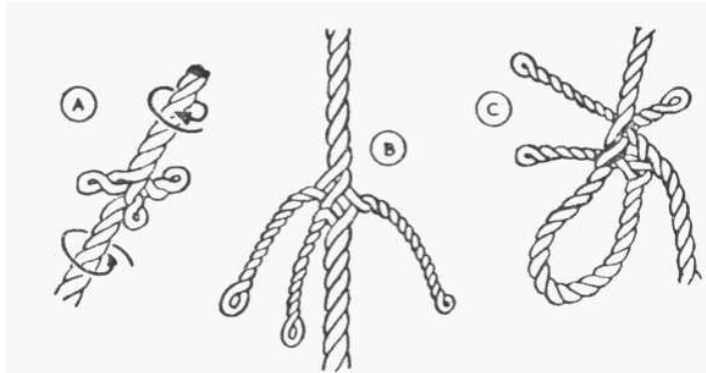

*Fig. 10. – Forming an eye in the middle of a rope.*

To make the twisted strands, take a portion of the rope firmly in the hands and turn each hand in opposite directions so that there is a tendency for the natural twist of the strands to straighten out (A). As the turning is continued, the strands will separate and continue twisting back around themselves. Continue in this way until the three "ends" arc long enough for tucking (B). Form the rope into an eye, then commence tucking with the "ends" exactly as for a common eye splice.

Sailmaker's splice. – This splice is used to form an eye in the end of a rope in such a way that the form of the rope is kept right up to the base of the eye. This is an advantage in the making of a bolt-rope for a sail, where the rope is attached to the sail by sewing. It is not as strong as a common eye splice as the strands have a tendency to "draw".

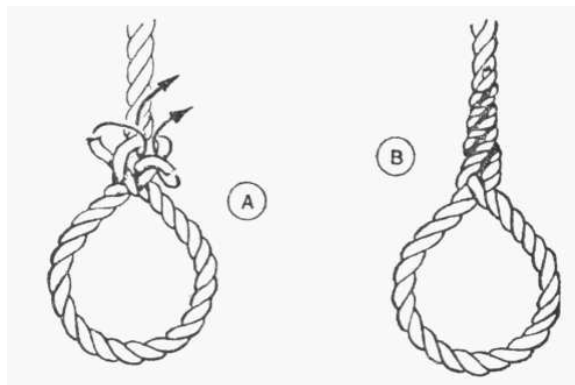

*Fig. 11. – A sailmaker's splice (first method).*

A sailmaker's splice is usually commenced exactly as for a common eye splice up to the completion of the first tuck (Fig. 11). From this point (A) take each end strand back around the main strand that it is already under. For the neatest job, commence tapering after the first tuck and make a total of four tucks each end strand going around the same main strand four times (B).

An alternative and preferable method of making a sailmaker's splice (Fig. 12) is to commence tucking the strands in the opposite way to a common eye splice, i.e., with the lay instead of against it.

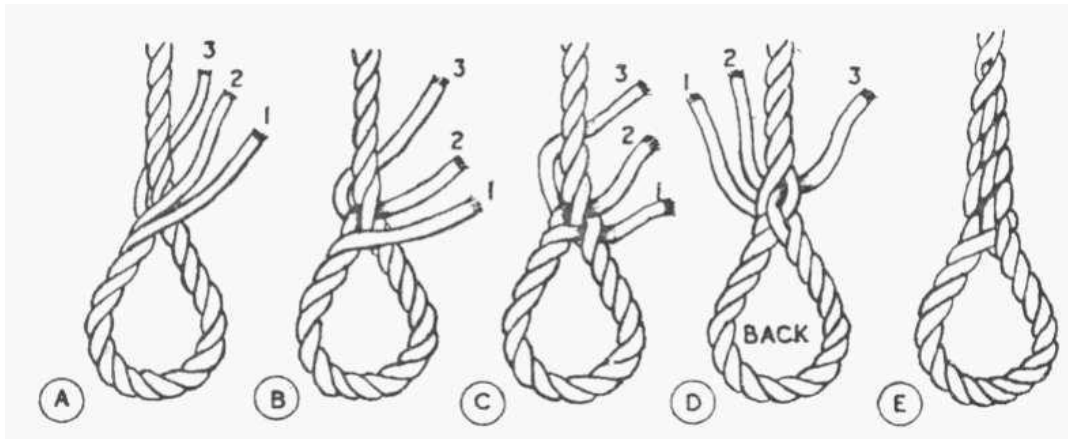

Fig. 12. – A sailmaker's splice (second method).

The rope is shaped into an eye and the end laid across the standing part with No. 2 end strand in front, roughly parallel with the lay, and one behind (A). Tuck the centre (No.2) strand under a convenient strand of the standing part (B) then tuck No. 1 strand in where No. 2 comes out (C). Turn the rope over and tuck No. 3 strand under the remaining strand of the standing part (D). The sequence of tucks is the same as for a common eye splice but they are worked in the opposite direction around the rope. From this point proceed exactly as in the first method taking each end strand back around the main strand it is already under (E).

Eye Splice, wormed and collared. – This is a purely ornamental variation of the sailmaker's eye splice, which looks most effective in four-stranded rope. It is longer and uses up more rope than the ordinary splice. Because of the decorative work at the end of the splice it cannot be run close up to a block (Fig. 13).

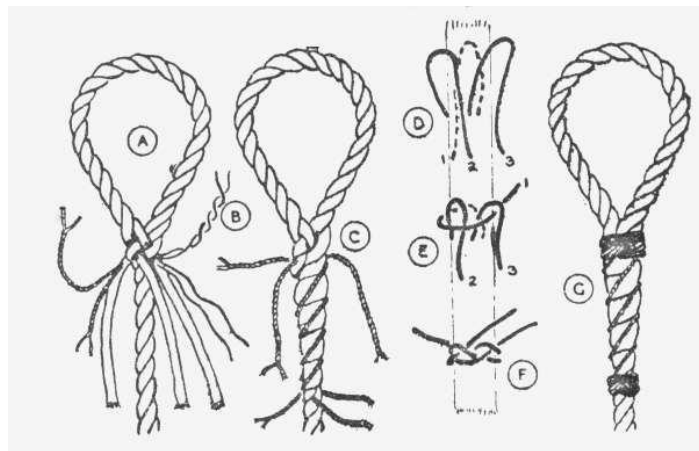

Fig. 13. – An eye splice, wormed and collared.

To make the splice, commence by making the first tuck as if starting a sailmaker's splice, but using considerably longer strands (A). From each strand separate four yarns and with the remaining yarns complete a sailmaker's splice, tapering it well.

Lay up the remaining yarns into two-yarn nettles, i.e., twist them up in pairs between finger and thumb left-handed (B), making two nettles for each strand.

Take one nettle from each strand and worm it around the rope (i.e., lay it in a space between two strands) down to the end of the splice, then tuck it under one strand of the rope. Arrange all the nettles so that they finish level (C).

The two groups of nettles are each formed into footrope knots, in the following way: – Take each nettle and double it back along the rope, keeping the end to the right of its fixed part (D). Working to the right, take one end around both parts of its neighbour and through the next bight (E). Do the same with the other ends. This completes a single footrope knot (F). To double it take each end around alongside its adjoining member. Following around under two parts in each case will result in a double knot. If a trebled knot is desired, follow round again. Complete by working all the strands tight with a spike, then cut off the ends (G).

The completed footrope knot looks very much like a Turk's head, and is only one of the ornamental knots suitable for making the collars.

Eye Splice with Single Collar. – Apart from its obvious decorative value this splice (Fig. 14) is useful where the eye has to run up close to a block.

The splice is started as for a common eye splice, but each strand is only tucked once, then: hove tight The strands are then worked into a collar which may be a footrope knot, as just described, or a manrope knot.

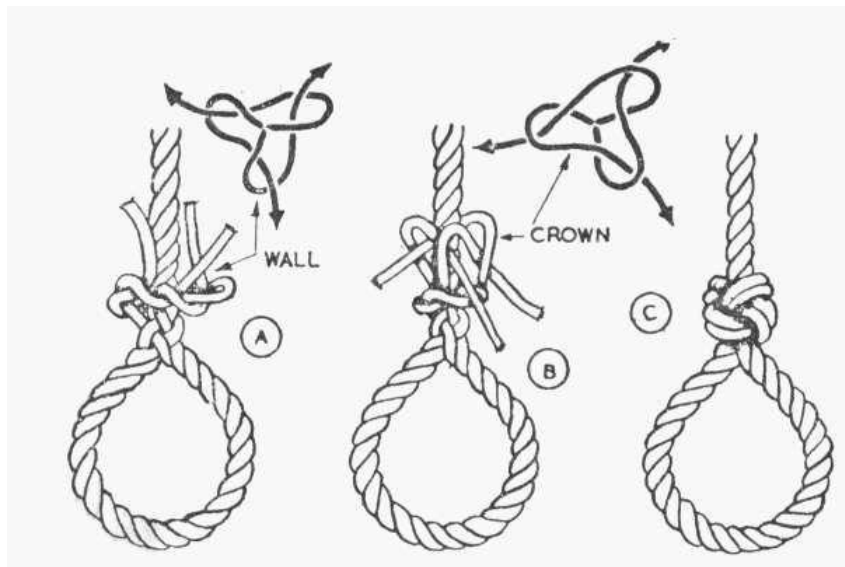

Fig. 14. – An eye splice with a single collar.

A manrope knot, which consists of a wall knot, topped by a crown knot and followed round once, is made as follows:

Take each strand to the right and pass it up wider its neighbour, the last strand going up through the bight of the first (A). Continuing the same way round, take each strand down over its neighbour (B). This is shown in greater detail in Fig. 3. Now let each strand follow around again, keeping alongside the strand it is already adjoining. Work as tightly as possible and cut the strands off short (C).

Eye Splice, grafted. – "Grafting" is the name given to the interweaving of the yarns of a rope so as to obtain an ornamental finish. The process is the same as in one method of "pointing". Splices may be completed by grafting, one example only being given here. A large number of patterns are possible, but the reader is referred to a book on fancy ropework for further information on this subject.

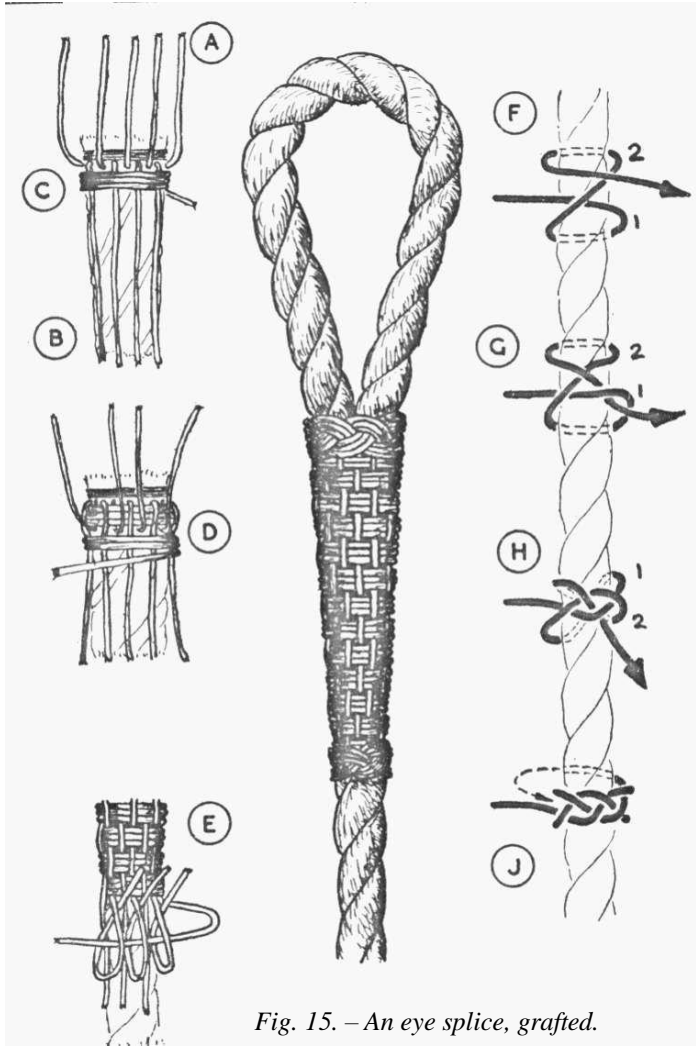

Fig. 15. – An eye splice, grafted.

An eye splice may be grafted (Fig. 15) in two ways: the strands may be tucked once and the strands separated into yarns which are used for grafting, or the splice may be completed and separate strands seized on to make the grafting. Whichever method is used, work sufficient yarns around the rope as worming then arrange the remaining yarns into an even number of two-yarn nettles. Take alternate nettles along the rope (13). Halfhitch two or three turns of light line around the under nettles close up to their junction. This is called the warp (C). Lay the turned-back nettles down along the rope and turn back the others (D). Half-hitch on two or three more turns of warp. Continue this up and down weaving for a sufficient length. Finish by turning back the ends of one set of nettles and threading the warp through them (E). A neater effect is obtained if a few nettles are used to form footrope knots at the beginning and end of the grafting.

While footrope knots are best, an easier alternative is to add separate Turk's head knots, made in the following way:

Take the line around, almost the same way as in making a clove hitch, except that the end does not go under the last turn (F). Take this end under the first turn (G) and lift the second turn over the first (H). Pass the end down between the loops (J). This completes a single Turk's head. Double or trebled by following around again.

German Eye Splice. – This splice (Fig. 16) differs from the common eye splice in the formation of the first tuck, by introducing a "locking tuck". The locking tuck – the arranging of two end strands in opposite directions under the same main strand – is frequently used in wire splicing, but is not usually found in rope work.

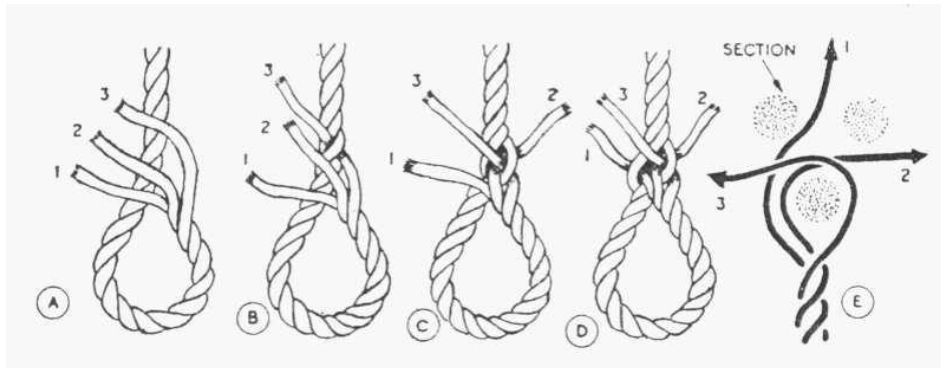

Fig. 16. – A German eye splice.

To make a German eye splice, bend the rope into an eye and lay all three end strands across on top of the standing part at right-angles to its lay (A). Tuck No. 3 strand under a convenient main strand against the lay (B), then take No. 2 strand under the same strand, but with the lay (C). Tuck No. 1 strand in the same space as No. 2, but against the lay (D). There should now be one strand emerging from each space in the standing part (E). From this point tuck "over and under one", as for a common eye splice.

## CHAPTER 4.

### SPECIAL EYES .

The splices dealt with in this chapter are all used for forming eyes for special purposes and are of different construction from the common eye splice and its variations. There has been a certain amount of confusion in the names of some of these splices, but those given here appear to be most commonly used.

Flemish Eye. (Also called a spindle or artificial eye).—This differs from the majority of other splices in being equally suitable for braided or laid rope. It is of particular value when a very small eye is required in the end of a rope. Making a Flemish eye is a little more tedious than most other splices as it has to be worked in the separate yarns of the rope (Fig. 17).

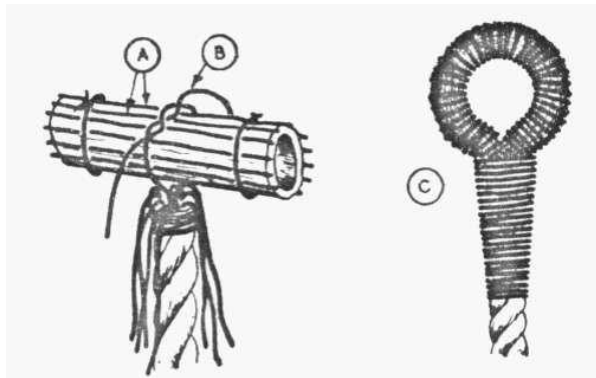

*Fig. 17. – A Flemish eye.*

To make the eye, at a suitable distance from the end whip the rope, then separate the strands between there and the end into individual yarns. Use a piece of round rod or tube to gauge the size of the eye. The inside measurement of the eye will be the same as the diameter of the rod. To assist in controlling the splice as it is formed, two humps may – be built up each side of the centre, by binding around the rod with any available light line. While this arrangement is definitely a help, the humps can be dispensed with if care is taken.

Fasten short lengths of yarn along the rod at fairly close intervals (A). These will later be used as stops. Separate the yarns of the rope into two equal groups. Take a pair of yarns and join them over the rod with an overhand knot (B). Repeat with all the yarns, staggering the knots as much as possible, so as to avoid forming lumps.

Unfasten the yarns laid along the rod and use them to draw the knotted yarns into a neat ring, then withdraw the rod. The eye must now be tightly served over, starting at the top and working down each side to the neck. The ends of the yarns hanging down must be tapered and laid over the rope; straight if a braided rope, or wormed around if a laid rope. They are then served over to complete the splice (C). If it is expected that the eye will have to stand hard wear it may be further protected by cockscombing (see Fig. 45).

Grommet Splice. (Also called an artificial eye). – This splice (Fig. 18) may be used as an alternative to a common eye splice or a Flemish eye, and is about the same strength.

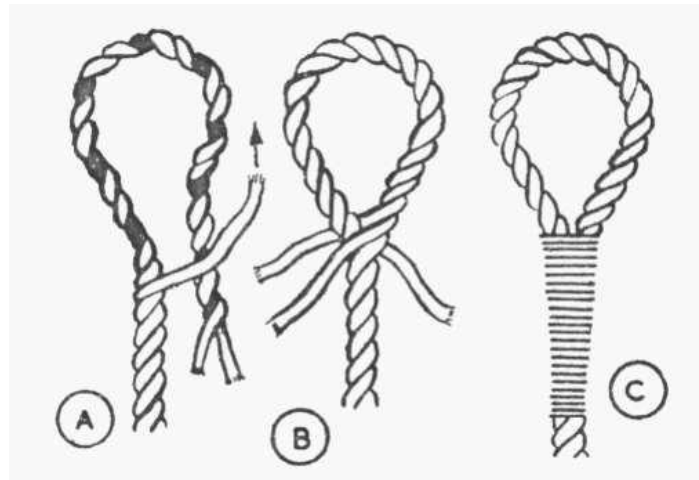

*Fig. 18. – A grommet splice.*

To make a grommet splice in three-stranded rope, unlay one strand for a distance rather more than is needed to make the eye. Bend the remaining two strands into the eye (A), taking care not to disturb their lay. Lay up the single strand in its original space between the other two, but working the opposite way round (B). Separate the yarns of each strand and worm them around the ropes, scraping them into a neat taper, and finally marl and serve over (C).

To form the splice in four-stranded rope, proceed in the same way, but after laying up one strand the opposite way to the other three, unlay the strand which comes opposite it in the formation of the rope, and lay that up also the opposite way round. There will then be two strands going each way around the eye. Complete as with the three-stranded rope.

A variation of this splice is to make it the same way up to the completion of the laying up, then tuck the ends, either "over and under one" as in the common eye splice or around separate strands as in the sailmaker's splice.

Chain Splice. – This is used where a rope has to be spliced to the end of a chain in such a way that the finished splice is thin enough to follow the chain through fairleads etc. It does not have the strength of a common eye splice as only two-strands form the loop (Fig. 19).

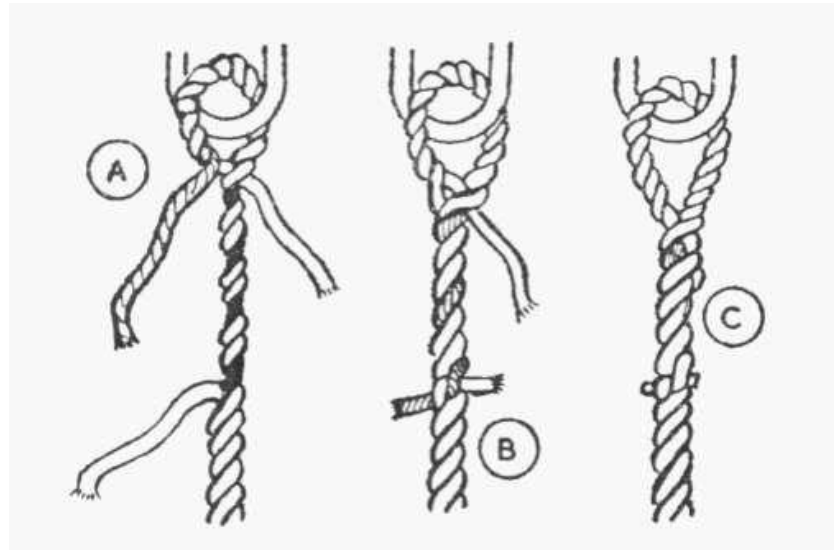

*Fig. 19. – A chain splice.*

To make the splice, unlay one strand for rather greater distance than is needed to form the loop. Bend the remaining two strands into a loop and tuck one of them under a strand of the standing part (A). Lay the other loop strand up in the space left by the separate strand. Take it some way along the standing part, then join the two strands in the same way as in long splicing (B). The other strand should be scraped to a taper and tucked two or three times more (C). Complete the splice by stretching and rolling underfoot, then serving over.

## CHAPTER 5.

### END TO END SPLICES.

There are a number of conditions in which ropes have to be joined more or less permanently end to end, where the common short and long splices may not be suitable, because of differences between the two ropes, shortness of ropes, etc.

**Shroud Knots.** – There are a number of variations of this method of joining ropes, which, although called a knot, is in effect more of a splice, and certainly deserves a place in a book of splices because of its one great advantage – its economy in material; a shroud knot using up less rope than any other joining knot or splice. It was originally used to repair a shroud after it had been shot a way in action – a case where the minimum shortening was desirable.

*First variation* (Fig. 20). – This is the commonest form of shroud knot. Unlay the ropes for a short distance and marry them (A). With the strands of one rope make a wall knot, in the opposite direction to the lay, around the other rope (B). Pull the knot tight and do the same with the strands of the other rope (C). Pull both knots tight anti close together (D). Taper the ends and worm them around the rope, then finish by serving over (E).

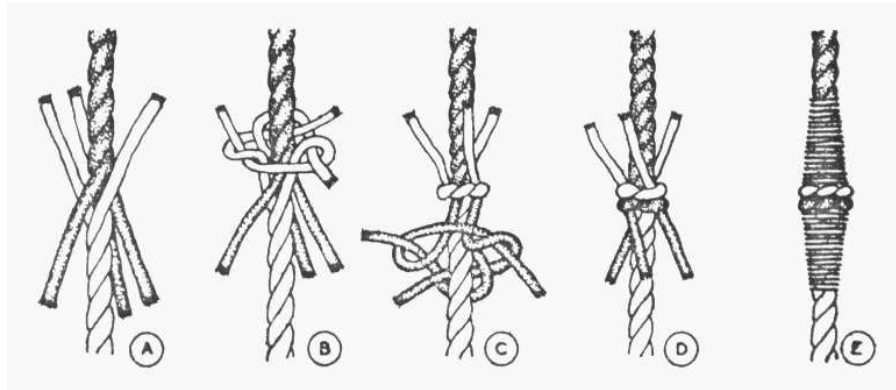

Fig. 20. – A shroud knot (first variation)

*Second variation* (Fig. 21). – This is made in a similar way to the first variation, but crown knots (see Fig. 14) are used instead of wall knots. This variation is sometimes called French shroud knotting.

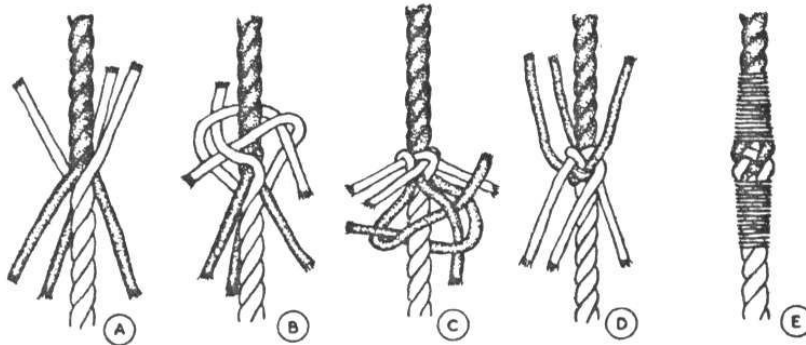

Fig. 21. – A shroud knot (second variation).

Unlay the ends and marry them (A). Form a crown knot in the opposite direction to the lay with the ends of one rope around the other (B). Pull tight and repeat with the other ends (C). Pull the knots close together (D) then taper the ends, worm them around the rope and serve over (E).

*Third variation* (Fig. 22). – This method uses a crown knot on one rope and a wall knot on the other, the strands at the finish all pointing one way. This is also sometimes called a French shroud knot.

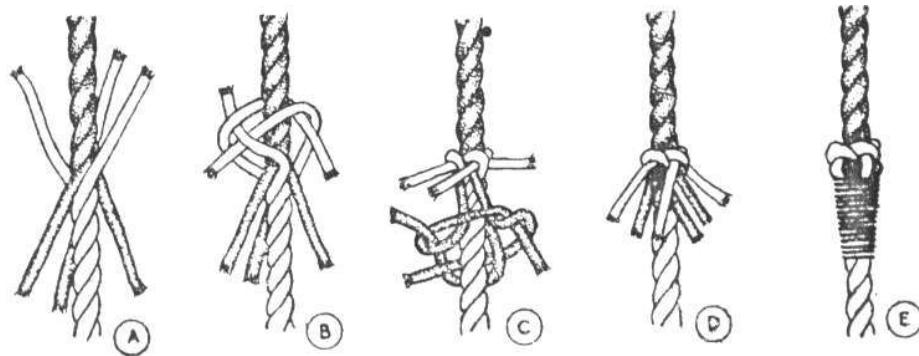

Fig. 22. – A shroud knot (third variation).

Unlay the ends and marry them (A). With the strands of one rope make a crown in the direction against the lay around the other rope (B). With the strands of the other rope make a wall knot against the lay (C). Pull the knots up close (D) then taper the ends well, lay them down over the rope and serve over (E).

*Fourth variation* (Fig. 23). – This is a development of the second variation. After forming two crown knots and pulling them fairly closely together it will be seen that adjoining pairs of ends lie in opposite directions alongside each other. Take each end and follow it round alongside its partner until the whole knot is doubled, then cut the ends off. The finished knot looks like a Turk's head or footrope knot.



Fig. 23. – A shroud knot (fourth variation).

Short splices (3-strand into 4-strand). – Three-strand rope may be joined to four-strand rope in one of two ways; either by making the three-strand rope into four-strand for a suitable distance, or by making a length of the four-strand into three-strand. In strength there is little to choose between the two methods.

*First method* (Fig. 24). – Unlay the three-strand rope (A) for a distance sufficient to make the ends for tucking (Y) and a little further than it is expected the strands of the other rope will reach after tucking (X). Take one of the strand and divide its yarns into two equal parts, laying them up between the fingers to form two half-strands (B).

Take the two full thickness strands and the two half-thickness strands and lay them up together for the distance 1 making a four-strand rope for that length.

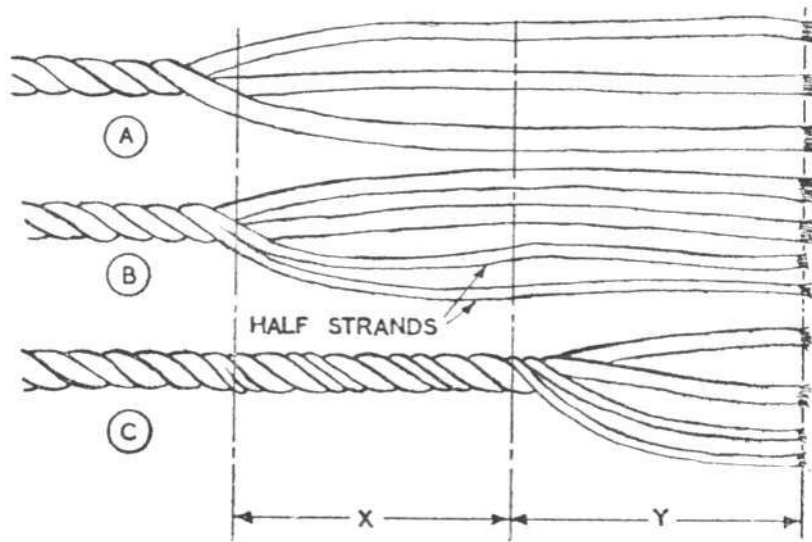

Fig. 24. – A short splice (3 strand into 4 strand) (first method).

Complete the splice in the same way as the common short splice, marrying the unlayed strands of the four-strand rope into the four ends of the three-strand rope, making two full and two taper tucks each way.

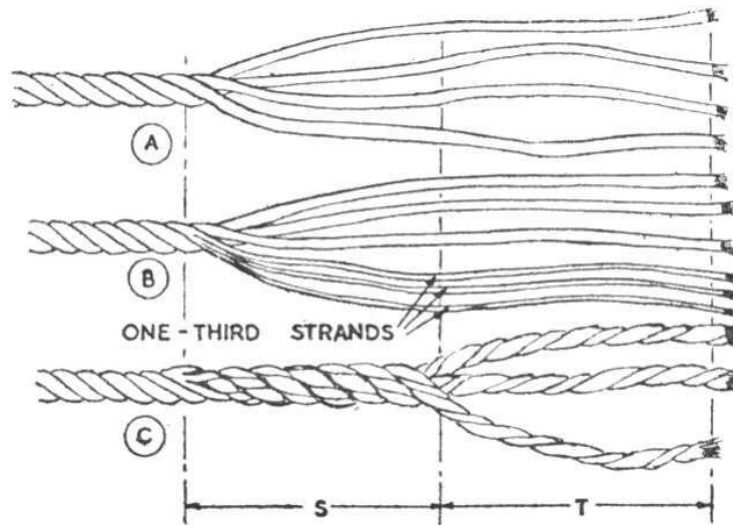

Fig. 25. – A short splice (3 strand into 4 strand) (second method).

*Second method* (Fig. 25). – Unlay the end of the four-strand rope (A) for a distance sufficient for tucking (T) and a little further than it is anticipated the end strands of the other rope will reach when tucked (S).

Divide the yarns of one strand into three equal parts (B) and twist them around the other three strands. Lay up the strands for the distance S, making a three-strand rope for that length (C).

Complete the splice in the same way as the common short splice, marrying the unlayed strands of the three-strand rope into the three ends of the four-strand rope and making two full and two taper tucks each way.

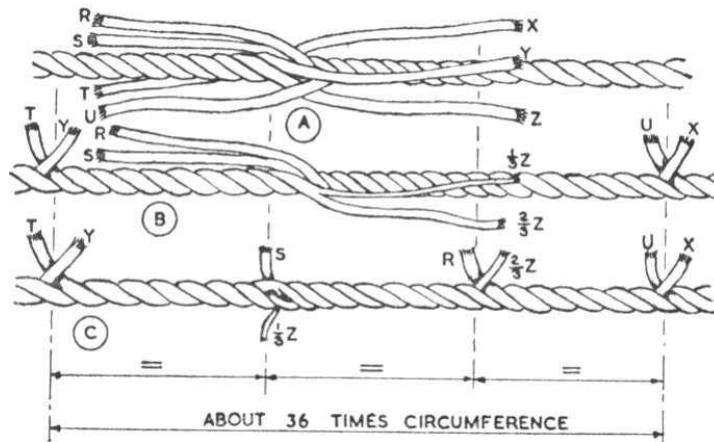

Fig. 26. – A long splice (3 strand into 4 strand).

Long splice (3-strand into 4-strand).—The strength of this splice (Fig. 26) is governed by its length in the same way as the common long splice. For an average length splice unlay the end of the three-strand rope for about 24 to 30 times the circumference, and the four-strand rope for about 12 to 15 times the circumference. Marry the ends (A) letting two strands of the four-strand rope (R and S) lie in one space of the three-strand rope.

Unlay one strand of the three-strand rope (B) and lay up one strand of the other rope in its place (Y and T). Do the same with another pair (U and X) in the opposite direction. By working each pair almost to the end of the laying up strand the junctions should finish about 36 circumferences apart.

Split the remaining strand of the three-strand rope (Z) into two unequal parts (roughly 2/3 and 1/3). Half-knot the thinner part to one of the remaining strands of the four-strand rope. Commence unlaying the last strand of the four-strand rope and lay up the thicker part of strand Z in its place. Arrange the junctions so that they are equally-spaced (C). Secure the ends by any of the methods described for the common long splice.

Alternatively, in place of the actions in the last paragraph, keep strand Z the full thickness and lay it up in place of R to the same point as shown for 2/3Z. Finally tuck S where it is and secure all the ends by any of the methods described for the common long splice.

Short Splice, knotted. – This differs from the common short splice only in the treatment of the strands when marrying the ends. Instead of the plain marrying, each end strand is twisted with its opposite number into a half knot. In the case of right-handed rope each strand is mated with the opposing one on its right (Fig. 27). When the knots are pulled tight the ends lie in position ready for tucking.

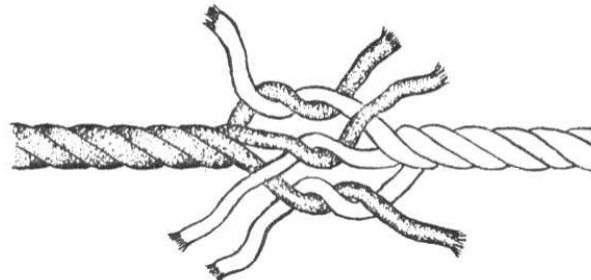

Fig. 27. – Commencing a short splice, knotted.

While this method of starting a short splice has the advantage of holding the parts together when starting it is generally considered to result in a weaker splice than the conventional method of starting.

Short Splice (rope to wire). – There are a number of slight variations in making this splice (Fig. 28), but in all methods the six strands of the wire rope are paired (the heart is cut out) and married with the hemp strands (A), each pair being treated as a single strand and placed between two strands of the hemp rope (B).

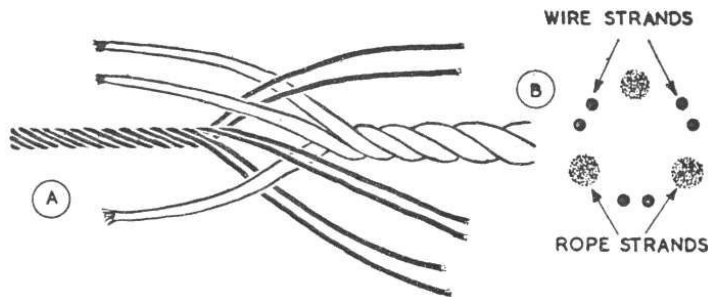

Fig. 28. – Commencing a short splice, rope to wire.

When the difference in size between the two ropes is not great, unlay the two ends and taper the strands of the hemp rope straight away. Marry the strands—two of wire to one of hemp and tuck the wire "over and under one" into the hemp rope. Tuck the hemp rope strands into the wire "over and under two". Three tucks each way are usually sufficient. Taper the last wire tuck by reducing to one strand.

If the wire is much thinner than the hemp rope difficulty will be found in tucking the hemp into the wire. Instead, unlay the hemp for some way (say 12"), taper the strands fully for the whole unlaidd length and lay up the strands to within a short distance of the end. Marry the wire and hemp, letting the unlaidd wire strands be considerably longer than the unlaidd hemp (2 or 3 ft. is not too much, if the greatest strength is required).

Tuck the pairs of wire strands "over and under one" into the hemp rope for as far as they will go, tapering by reducing to one strand towards the end. Cut off the ends of the hemp strands.

In both cases the best finish is obtained, if the wire is suitable, by separating the wires at the ends of each strand and sewing each wire, with a sailmaker's needle, into the hemp rope. For the best finish serve tightly over the whole splice.

Long Splice (rope to wire). – This splice (Fig. 29) is more suitable than the short splices for cases where the hemp rope is considerably thicker than the wire, say upwards of four times greater.

Unlay the hemp rope for rather more than would be needed for a common short splice. Taper the strands. Unlay the wire rope for a considerably distance (100 to 150 times its own diameter). Cut out the heart. Take three alternate strands and lay them up to form a three-strand wire rope. Marry the ends of this rope with the end of the hemp rope (A), letting strands R, S and T alternate with strands U, V and W. Put a temporary seizing over the junction.

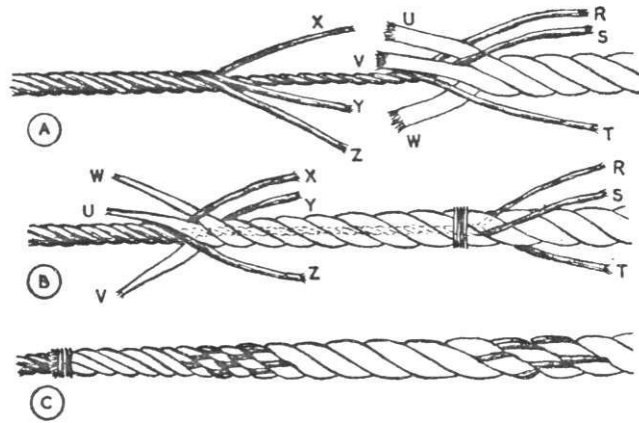

Fig. 29. – A long splice (rope to wire).

Lay up the hemp strands around the thin wire rope as far as the other three wire strands, letting strands U, V and W finish up alternating with strands X, Y and Z (B).

NOTE. – The two marryings should be much further apart than shown in the figure, where they are closed up for convenience in illustrating. Remove the seizing. At both marryings tuck the wire around the hemp strands with the lay in the same manner as for a sailmaker's splice, i.e., work each end around the strand it is already under four or five times. Cut off the wire ends, or sew them into the hemp strands, as described for the short splice, rope to wire.

Lay the remaining ends of the hemp strands around the wire, with the lay, finishing with a tight seizing (C). Finally, for the neatest finish, serve over the entire splice.

Grecian Splice. – This splice (Fig. 30) is of more ornamental than practical value, although it was used for repairs in the days of hemp standing rigging. It is neat, but takes some time to do and uses up more stuff than a shroud knot or a common short splice.

Unlay the ends of the ropes to be joined for nearly twice as much as would be needed to make a common short splice and put on seizings. Note which are the outside yarns in each strand at the seizings and unlay them back from the ends, removing approximately the outside half of each strand; then lay these yarns up into stout nettles between the finger and thumb. Make the same number of nettles on each rope. Turn the nettles back over the seizings, out of the way, and lay up the thinned strands for just sufficient distance to take one tuck of short splicing.

Marry the ends (A) and make one tuck each way as in starting a common short splice. From each of the thinned strands take sufficient outside yarns to worm the rope and cut off the rest.

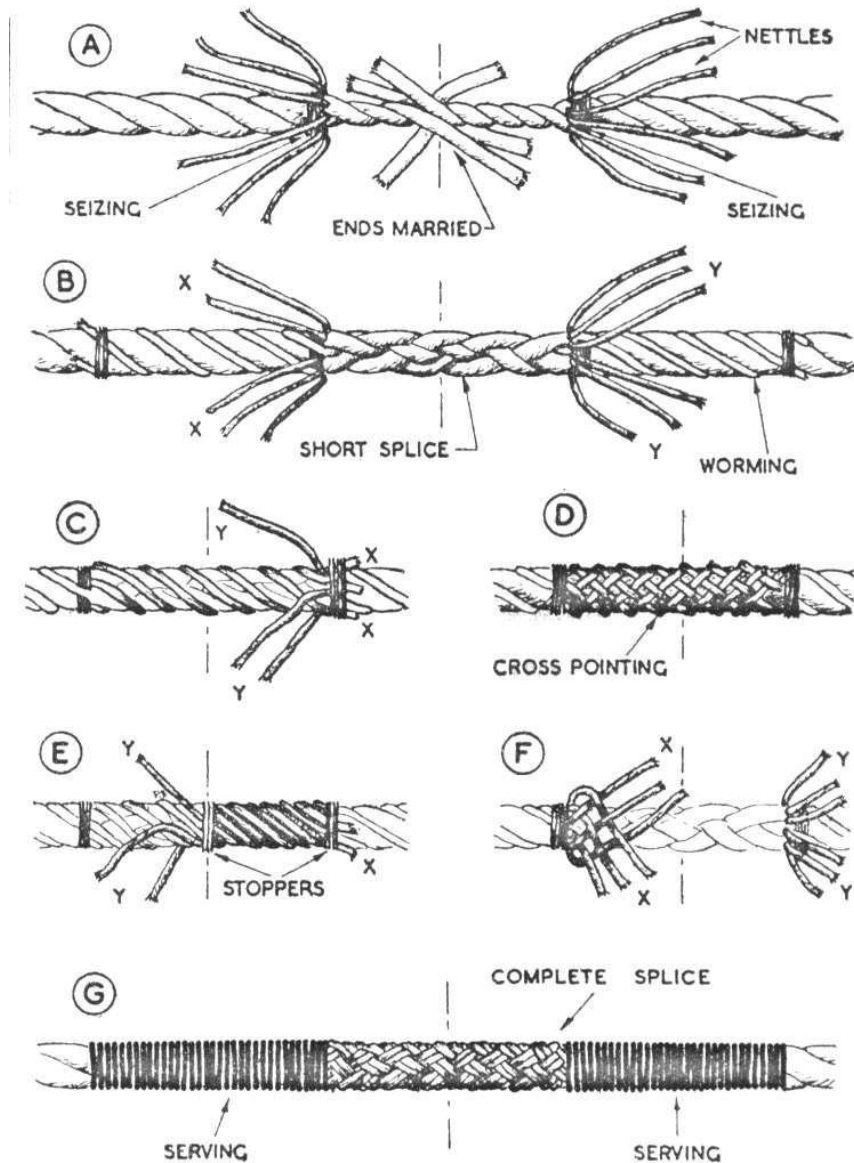

Fig. 30. – A Grecian splice.

Worm the rope each side for a distance about the same as the length of the short spliced centre (B).

The nettles, which have not so far been used, are next formed into cross-pointing over the short splice. There are several ways of doing this. The most straightforward method is: Take the nettles from one end (X) spirally around the rope, finishing up at the opposite end between the other nettles (C). The best angle of twist is about 45 degrees to the centreline of the rope. Securely stopper their ends. Take the other nettles (Y) spirally, in the opposite direction back to the other end, tucking them "over and under one" into the first nettles (D). The nettles may be worked singly, doubled or in threes, as preferred.

Alternatively, after laying nettles X spirally to the opposite end, lay nettles (Y) beside them. Put a temporary stopper at the middle of the splice (E). Now, treating the two sets of nettles in the same way as rope's strands when shortsplicing, tuck one lot "over and under one" into the other lot from the stopper to the end of the splice. Get in as many tucks as possible. Remove the stopper and tuck the other nettles in the same way in the opposite direction.

The strongest, but most tedious method of cross-pointing the splice is as follows: – With an even number of nettles at each end, start at one end (X) using all the nettles, and take them alternately in opposite directions over and under each other (F). Continue this to the opposite end. At that end take nettles (Y) and tuck them back through the cross-pointing letting each nettle follow its opposite number back to the opposite end, so doubling the cross-pointing. With this method the correct degree of tightness for the first half of the cross-pointing can only be found by experience.

To complete the Grecian splice, after cross-pointing over the short splice, taper the ends of the nettles, lay them down over the worming, then marl and serve over as far as the cross-pointing (G).

## CHAPTER 6.

### SPLICING CABLES AND BRAIDED ROPE.

Cable laid ropes may be spliced in the same way as hawsers, but because of their greater bulk it is necessary to introduce various means of tapering to prevent the splice being ugly and clumsy. Besides these splices, in which the three hawsers forming the cable are treated in the same way as the strands of a hawser-laid rope, there are a few splices particularly adaptable to the special construction of a cable.

Braided rope, usually formed of eight strands worked into a round sennit around a heart, cannot be spliced by any of the methods so far described, except the Flemish eye (see Fig. 17). Splicing braided rope is a slow and tedious job calling for careful workmanship and plenty of patience. Because of this many workers prefer to avoid the splice and use a knot or seizing in its place. However, the splices for braided rope described in this chapter are simple in principle, and facility in forming them will come with practice.

Ropemaker's Eye. – This splice is used to form an eye for holding the end when making a cable from three ropes (Fig. 31). Two of the cable "strands" are made from one doubled rope, while the other "strand" is a single rope (A).

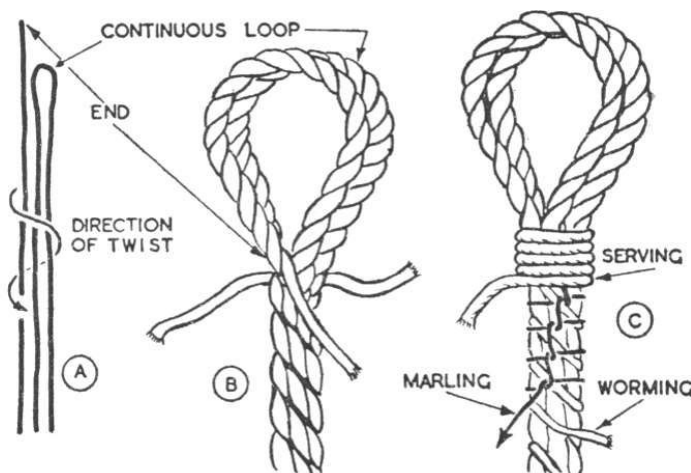

Fig. 31. – A ropemaker's eye.

Form the end into an eye of the same size as the loop formed by the other two ropes (B). Separate the strands of the end and worm them round the cable. Secure this worming with marling (a series of half-hitches in light line, put on tightly, but not close together). Cover the worming and marling with a seizing (C).

Admiral Elliott's Eye. – This (Fig. 32), like the ropemaker's eye, is used for putting an eye in the end of a cable. It can be used when starting a cable to be made of three separate ropes (instead of one doubled and one single rope), or used to finish off the three ends of a cable.

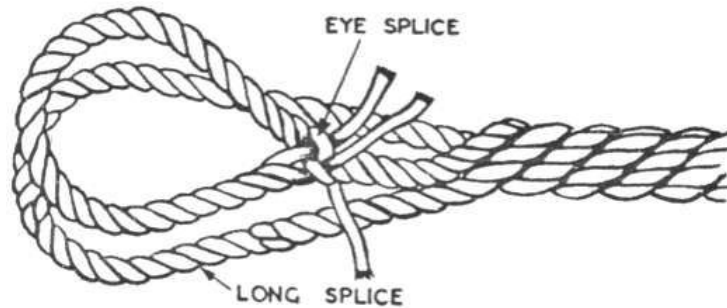

Fig. 32. – Admiral Elliott's eye.

Join two of the ends in a long splice. Turn the other end back to make a common eye splice, arranging it so that the ends of both loops are level. Keep the tucked ends of the eye splice fairly long and do not taper them. Use the three strands to worm around the cable, and complete the eye by marling and serving.

Common eye splice (cable). – To make a neat splice, unlay the three ropes for a sufficient distance from the ends to make the tucks and put on a stop. At about half of the distance from the ends to make the tucks and put on a stop. At about half of the distance from the end of each rope put on another stop. Separate the strands of each rope and taper them from the stop to the end (Fig. 33 A). After tapering the strands lay them up again to form tapered ends to the ropes (B).

Take off the stops and use the tapered ends to tuck into the standing part of the cable to form an eye splice in the usual way (see Fig. 4). The surplus ends may be cut off short, but a stronger and neater job will result if the ends are used to worm the cable and then marled and served over.

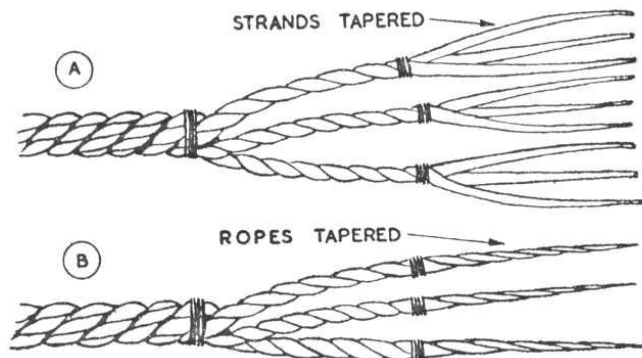

Fig. 33. – Preparing a cable for splicing.

Short Splice (cable). – Also called a drawing splice. Prepare the ends of both cables in the same way as described for the eye splice, by unlaying the ropes, separating the strands, tapering them and laying them up again. Marry the two cables and make a common short splice in the usual way (see Fig. 6).

Use the tapered ends to worm around the cable, then tightly serve over the worming. Instead of serving, each worming may be held by three seizings; one at the end of the splice, one at the end of the worming and the other midway between the two.

Alternatively, for a more decorative finish, make the splice in the same way, but do not taper excessively. Put seizings on at the ends of the splice. Separate sufficient strands from each rope to worm the cable and lay the rest up into stout nettles. Use these nettles to cover the worming, either with cross-pointing (see Fig. 30) or grafting (see Fig. 15), finishing off with another seizing.

Long Splice (cable). – Sometimes called a mariner's splice.

This is in effect a two-fold long splice – the rope forming the cable being laid up in each other's place as in a common splice long, then the strands of each pair of rope are treated in the same way.

Commence by unlaying the rope and marrying them, treating them in the same way as the strands of a hawser in the common long splice (see Fig. 7). Take a pair of opposing ropes, unlay one and lay the other up in its place. Do not take this as far as in the common long splice about three times the circumference of the cable is sufficient. Do the same with another pair in the opposite direction. Marry the ends of the ropes (Fig. 34) and long splice them together.

This is not easy and care must be taken to get each splice the correct tension so that when the cable is stretched all three ropes will be equally taut.

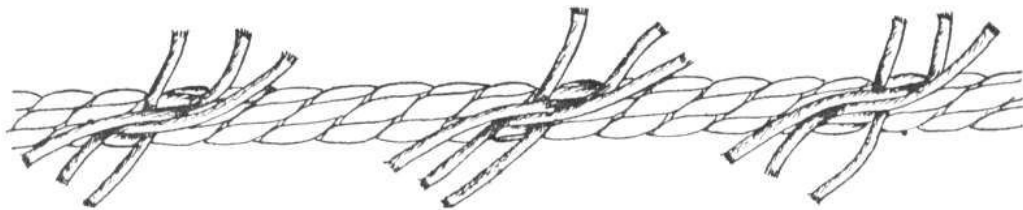

*Fig. 34. – Long splicing a cable.*

Staggered Short Splice (cable). – This is a compromise between the short and long splices, being less bulky than the short splice and less wasteful of material than the long splice.

Marry the ends of the cable, lay up and unlay pairs of ropes, then marry the ends of the ropes, as in the long splice (Fig. 34). Instead of long splicing the ropes together, short splice each pair, tapering the strands well after one tuck each way.

Eye Splice (braided rope). – Unlay the strands for 8 to 10 times the rope's diameter back from the end, and cut out the heart. As the yarns in each strand are not twisted around each other be careful to keep each set of yarns together. As soon as a sufficient length is unlayed; put a tight whipping on the end of each strand.

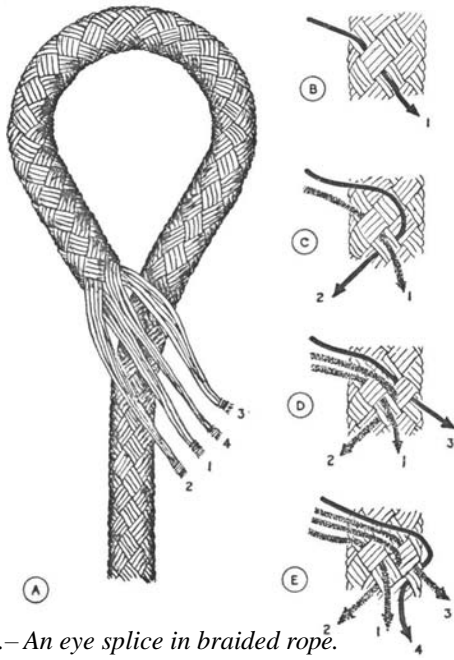

Fig. 35.—An eye splice in braided rope.

Bend the rope into an eye and arrange half of the end strands at the front and half at the rear of the standing part. Arrange the front strands as shown, 1 and 3 being left-handed and 2 and 4 right-handed (Fig. 33A). To open the strands of the standing part to permit tucking, a steel spike is needed. To assist this, the strands can be loosened by grasping the rope a short distance on each side of the desired spot and pressing the hands towards each other.

Lift the nearest right-handed strand of the standing part to end 1 and tuck end 1 under it (B) so that the end strand lies over the left-handed strand of the standing part already there. End 1 will then be attached to the standing part in position ready to start spirally around it in a left-handed direction.

Lift the left-handed strand that end 1 is covering and tuck end 2 under it (C). Lift the next right-handed strand and tuck end 3 under it (D). Lift the left-handed strand that end 3 is covering and tuck end 4 under it (E).

Turn the rope over and tuck the other four strands in the same way, except that now you are working to the opposite hand and "right-handed" and "left-handed" in the instructions should be read as vice versa. End 1 on the second side should start under the next strand to end 1 on the first side.

When all eight ends have been tucked once, every strand of the standing part should be covered by an end strand—four pointing left-handed and four right-handed.

To complete the splice, each end has to be tucked to follow the main strand it is already covering. Do this one tuck at a time with each strand. About four tucks are sufficient and the most that can be got into a tightly-laid rope.

Short Splice (braided rope). — Unlay the strands of each rope and secure the ends of the strands with whippings. — Marry the ropes and temporarily seize the strands of one to the other. Use the free ends to follow round the strands of the standing part of the other rope — each end entering on top of the adjoining opposing strand and doubling it for about four tucks. Remove the seizing and do the same with the ends in the opposite direction. Four tucks each way should be sufficient.

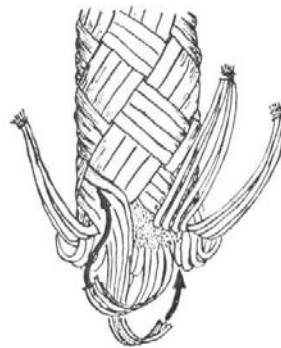

Fig. 36. — Methods of back splicing a braided rope.

Back Splice (braided rope). – There is no need to crown braided rope before back splicing it. Unlay sufficient to make the splice, cut out the heart and whip the ends of the strands. Take a pair of strands from opposite sides of the rope cross them over the end and tuck them on top of each other down the sides of the rope (Fig. 36). Take another pair and do the same, then the third and fourth pairs. When all are tucked once, take each in turn and tuck it again, following the strand it is covering. Four tucks should be sufficient.

## CHAPTER 7

### MISCELLANEOUS SPLICES.

There are a number of rope formations which are closely akin to splices and as such are entitled to a place in a book on splicing. Many other adaptations of the splicing principles are possible and, once the standard splices are learnt, the reader can adapt them to suit special circumstances.

Cringle to Sail (Fig. 37). – Unlay a strand from a suitable size of rope, taking care not to disturb its natural shape. The length should be rather more than three times the finished length.

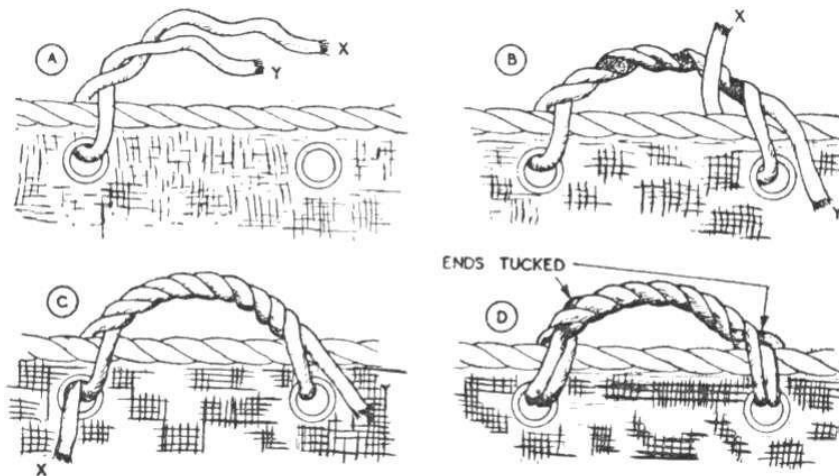

*Fig. 37. – Attaching a cringle to a sail.*

Pass the strand through one eyelet (A), keeping one end (X) twice as long as the other end (Y). Twist the two strands together and pass end X through the second eyelet (B). Lay it back around the cringle to the other end, forming a three-strand rope (C). Adjust the three parts to an even tension. Double the ends back on the cringle and tuck them into its strands, tapering for a neat finish (D).

For a stronger cringle it is possible to work around a further number of times. Any odd number may be finished off in the same way as for three strands. However, the larger number of strands do not lie together smoothly (due to the absence of a heart strand) and it is preferable to use a thicker strand worked three times only.

Another variation is to make the cringle as in fig. 37, but instead of tucking the ends, lay them up around the cringle until they meet on its crown making a four-stranded cringle. Finish the meeting ends off in the same way as a long splice.

Cringle to Rope. – A cringle may be attached to the bolt rope of a sail or net in the same way as to the eyelets in a sail, taking the ends through the rope instead of through the eyelets. Alternatively, a short length of rope may be cut to length and its ends spliced to the bolt rope (Fig. 38), in the same way as for a common eye or branch splice.

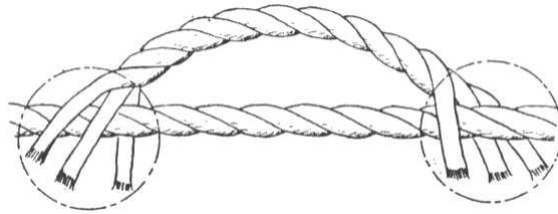

Fig. 38.— One method of attaching a cringle to a rope.

A better method (Fig. 39) is to use a single strand, tucking it under a single strand of the bolt rope (A), one end (Y) being long enough for tucking and the other end (X) being long enough for working the cringle. Double end X back around itself and under a strand at the same end as Y (B). Take it back to form the third strand (C). Even up the tension of the cringle and tuck both ends against the lay into the bolt rope (D).

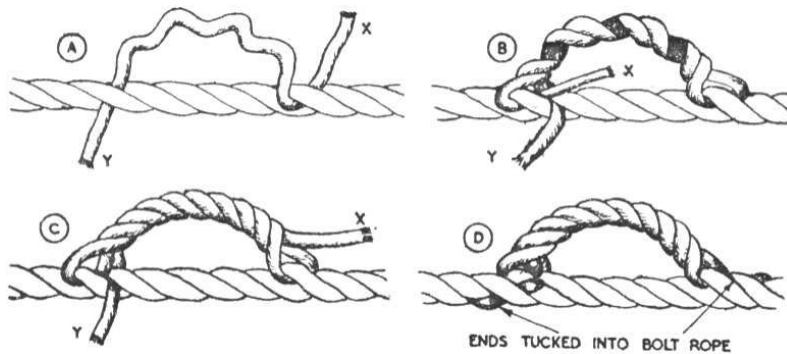

Fig. 39. – A second method of attaching a cringle to a rope.

Grommet. – A continuous ring of rope for use as a strop for a block or a hoisting sling can be made by short-splicing the ends of a length together, but this is rather clumsy. For a large strop a smooth job may be made by long-splicing the ends together, but for a short strop a grommet (Fig. 40) is the best method.

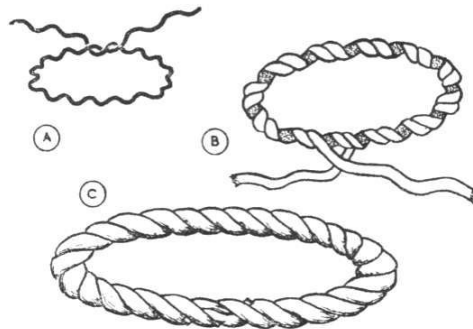

Fig. 40. – Steps in making a grommet.

Use a single strand with undisturbed lay, about 31 times the length of the final circumference of the strop. Bend it into the required size ring and commence twisting the ends together (A). Continue until they meet (B) then follow round once more with one end to make a three-stranded rope and finish off the ends as in a long splice (C).

Selvagee Strop (Fig. 41).—A selvagee strop is more supple than either a grommet or a ring made by splicing a rope's ends together. For a given circumference it is also stronger. Although for convenience in illustrating the strop is shown comparatively thick for its size (A), it shows to best advantage as a long strop for such purposes as attaching a block to a rope or pole (B).

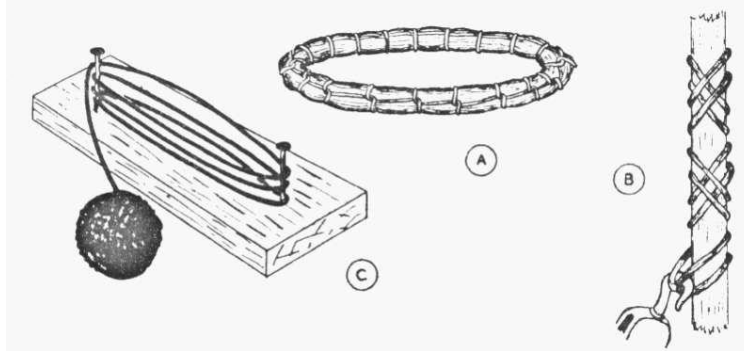
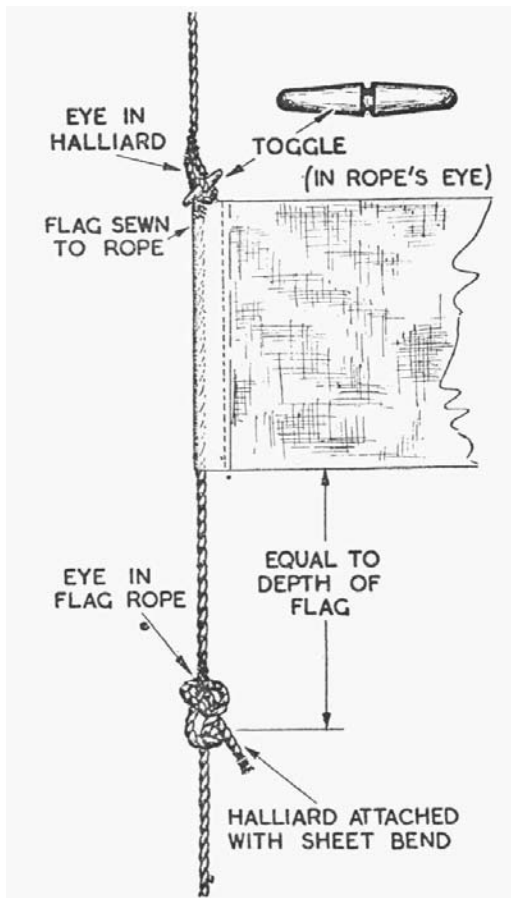

Fig. 41. — A selvagee strop.



The strop is made of any suitable light line, such as spunyarn or marline. Drive two nails into a plank at a suitable distance apart. Attach the end of a length of line to one nail and wind on sufficient turns to make the strop (C). Secure the yarns together by marling all round (A).

Flag rope. — The rope attached to a flag should be made in the proportions shown in the sketch (Fig. 42). The toggle, or sny, at the top should be held tight in an eye splice and the flag sewn to the rope as close up to the toggle as possible, so that the flag may be hauled fully up the truck of a mast. The eye in the end of the halliard should be just large enough to push the toggle through end-on. Making the rope tail below the flag the same as the depth of the flag ensures the correct spacing when two flags are hoisted together.

Padding Splice. — When one strand of a rope is damaged by wear or accident it can be cut out and replaced by a new strand (Fig. 43). Cut out the damaged strand for a length of twelve times the circumference or more and carefully lay in the new strand in its place, preferably letting the new strand follow the other in as it is being removed so as not to disturb the other two strands. Join the ends of the old and new strands by any of the ways shown for finishing a long splice.

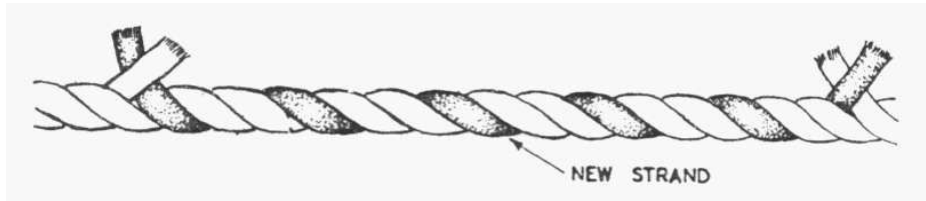

*Fig. 43. – A pudding splice.*

Guy line eye (Fig. 44). – This is a quick way of forming an eye in a rope. Some tent makers attach guy lines to eyelets in the canvas in this way.

If both ends of the rope are required, as in corner guys or when making mast shrouds from a single rope, bend the rope into a bight and lift one strand of the rope near the eye (A), then push the other side of the bight through the space. Lift a strand of the pushed-through rope near where it passes through the other and push the other rope under it. Work the two crossings up close together.

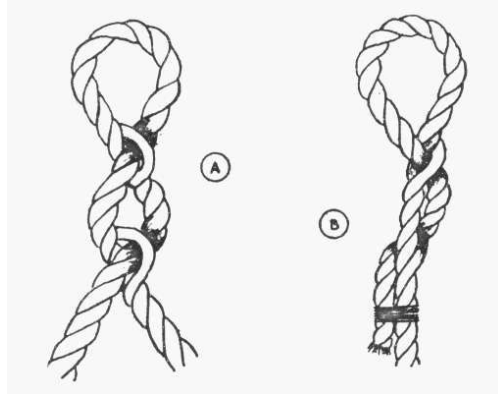
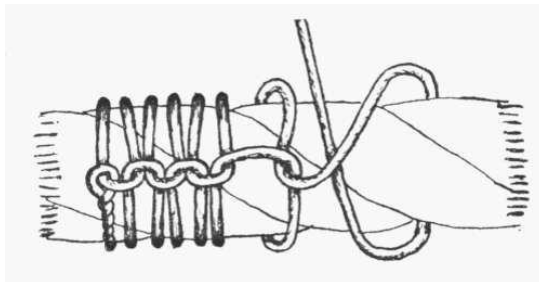

*Fig. 44.– A guy-line eye.*

If only one end is required, form the eye and push the end under a strand of the standing part. Take it over three strands and under another strand. Seize the end to the standing part (B).

Cockscombing. – Where a spliced eye is not protected by a thimble, and is subject to friction, it has to be protected in some other way. Serving over tightly, as shown for the Flemish eye (Fig. 17) is satisfactory, except that if any part of the serving is cut, the whole serving will unwind. Half hitching (marling) the turns of serving will hold on to any broken ends, but as the half hitches have to be staggered some will come on the inside of the eye and because of their greater thickness will tend to wear first.

This can be avoided if cockscombing is used (Fig. 45). Each turn of serving is half hitched on the outside of the eye, but the direction of the turns is reversed each time, resulting in a decorative line of half hitches around the outside of the eye.



*Fig. 45.– Cockscombing.*