

# KNOTTING

BY  
"GILCRAFT"

ILLUSTRATED WITH NUMEROUS DIAGRAMS



London  
C. Arthur Pearson Ltd.  
Henrietta Street

*First published 1929  
Reprinted 1931*

Printed in Great Britain at  
The Mayflower Press, Plymouth, William Brendon & Son, Ltd.

Downloaded from:  
"The Dump" at ScoutsCan.com  
<http://www.thedump.scoutscan.com/>

Thanks to Dennis Trimble for providing this booklet.



Editor's Note:

The reader is reminded that these texts have been written a long time ago. Consequently, they may use some terms or express sentiments which were current at the time, regardless of what we may think of them at the beginning of the 21<sup>st</sup> century. For reasons of historical accuracy they have been preserved in their original form.

If you find them offensive, we ask you to please delete this file from your system.

This and other traditional Scouting texts may be downloaded from The Dump.

**CONTENTS**

- I. HOW TO USE ROPES
- II. THE TENDERFOOT KNOTS
- III. MORE ABOUT THE TENDERFOOT KNOTS
- IV. SIX HITCHES
- V. SIX MORE HITCHES
- VI. SOME SPECIAL KNOTS
- VII. SIX STOPPER KNOTS
- VIII. SIX PLAITS
- IX. SPLICING
- X. BLOCKS AND TACKLES
- XI. LASHINGS
- XII. LIFTING WEIGHTS
- XIII. HOLDFASTS

## CHAPTER I

### HOW TO USE ROPES

EVERY art has its own technical terms, and the art of using ropes is no exception. The greatest artist in the use of ropes has always been the sailor, and most of the terms used in connection with ropes smack of the sea, and are unfamiliar to the landsman. We must therefore devote the first chapter to an explanation of the words we shall use later on.

Most of them, such as sheet, hitch, bend, and bight, are good Saxon, and are older than the Norman Conquest.

1. A rope generally has one end fixed, and only one end available for knotting. The fixed part is called the “standing end” or “standing part,” and the free one the “running end.” When teaching knotting, one end of the rope should invariably be held by the instructor, or fastened to something, or else the learner will use both ends and get totally false ideas. In the illustrations which follow the standing part is always indicated by a capital letter (A or B), and the running end by a small one (a or b).

Knotting should always be taught and practised with a stranded rope or cord, and not with string, which is apt to slip. Most ropes are what is called “hawser laid,” that is, as you hold the rope up in front of you the strands run from right top to left bottom. Some ropes and cords have three strands, some four.

2. A BIGHT, or LOOP –



3. A BEND is a knot for fastening two ropes together. The word is also used as a verb, to “bend” one rope to another.

4. A SHEET is a term which denotes a rope; especially the rope which holds down the bottom of the sail.

5. A HITCH is a temporary knot – generally the knot which fastens a rope to something stiff, such as a spar or a ring.

6. A ROUND TURN is a complete turn of the rope round an article such as a spar. As the ends are brought together it really amounts to two turns, as shown in Figure 2.

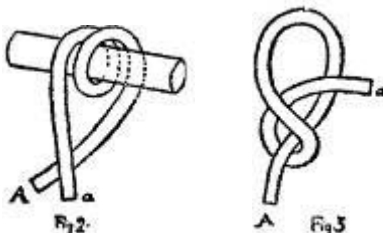

7. A HALF HITCH. Figure 3.

8. A THUMB KNOT – used for various purposes; sometimes to give a temporary finish to the end of a rope, which has not been whipped, to prevent it from unstranding.

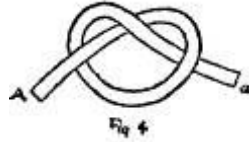

9. A FIGURE-OF-EIGHT KNOT. Much the same as the last, but stronger.

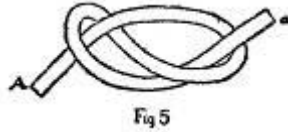

10. WHIPPING. – All ropes before being used should have the ends finished off in some way, to prevent them from coming unstranded. Whipping is a neat method, and is carried out as follows:

Take a piece of twine, and lay it along the rope to be whipped, the ends of twine and rope together (Figure 6). Then, at a point two inches or so from the end of the rope, begin winding the twine round the rope and itself, keeping the turns together and pulling up tight (Figure 7).

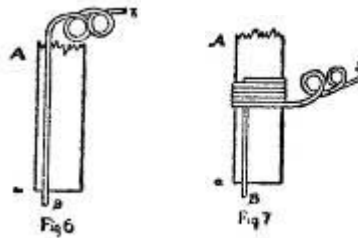

After about six turns, lay the twine in a loop about four to six inches in length along the rope, being very careful to hold the turns tight with finger and thumb (Figure 8). Then go on with your turns, now over both returns of the twine (Figure 9). After about six more turns, pull the remains of the loop through, and cut off both ends short.

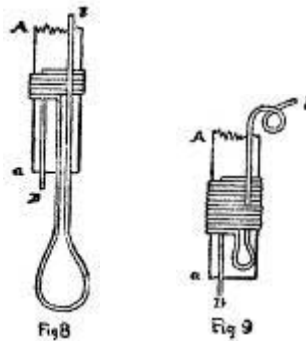

11. MOUSING A HOOK is to close in the back of a hook and its “bill,” or point, to prevent a rope or eye from jumping out of the hook. Take a few turns with twine or small rope round back and bill, then a few turns round the first turns, and finish off with a Reef Knot, as you see here.

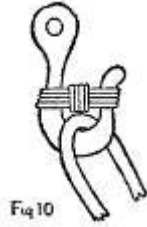

12. SEIZING OR STOPPING is a method of securing the end of a rope (generally to another) to prevent it from getting loose, and so causing the knot behind it to work loose. A few turns of a piece of twine finished with a Reef Knot, will meet temporary requirements; if the seizing is to be permanent, a whipping can be used.

## CHAPTER II

### THE TENDERFOOT KNOTS

#### THE REEF

So called because it is used to tie the “reef points” on a sail. These are short lengths of rope sewn in horizontal rows on each side of the sail, so that when it is partially lowered, because the wind is high, they may hold up the slack at the bottom of the sail by being tied across underneath.

USE: The above description points to the use of the knot – to tie two ropes together when there is a pressure down on some object, in this case the slack of the sail.

In ordinary practice a Reef is used to secure a parcel, or a folded tent. The knot can also be used when there will always be a strain on it, but it is not, strictly speaking, a “give-and-take” knot – that is, if the strain slackens, it is liable to work loose. It is, however, the most generally used knot for many purposes.

The completed knot:



To tie – first twist the running ends together:

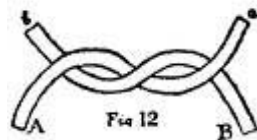

OR

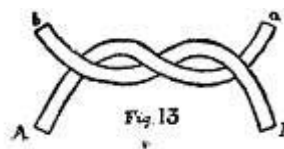

Then twist again, taking care that the standing part of one rope and the running end of the other lie together:

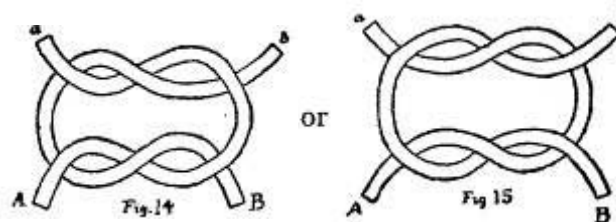

If they do not lie together, the result will be a “Granny,” which will slip:

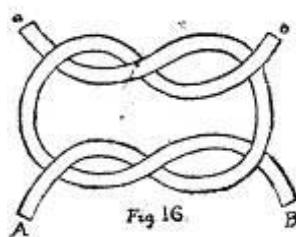

**THE SHEET BEND**

USE: To tie (bend) two ropes (sheets) together. The single Sheet Bend should be used for dry ropes only, though one may be somewhat thicker than the other.

The knot – Aa being the thicker rope, Bb the thinner – consists of a loop or bight on the thicker rope, and a Half Hitch on the thinner, and is less liable to work loose when the strain is off than the Reef:



It should be noticed that the two running ends come out on different sides of the knot. This is the best way of tying it; if they come out on the same side the grip of the knot is not so quick. To tie – take a loop at the end of the thicker rope between thumb and fingers of left hand, running end to left:



With the right hand pass the running end of the thinner rope through the loop from behind, round the back of the loop, and downwards under itself in front.

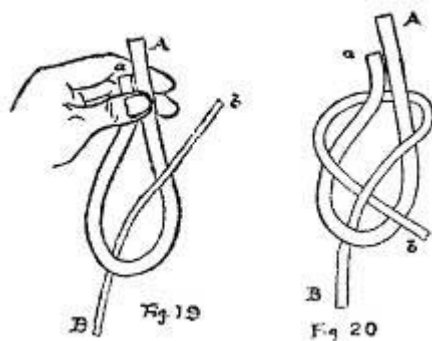

**THE CLOVE HITCH**

USE: For securing a rope to a spar or pole.

The Clove Hitch completed:

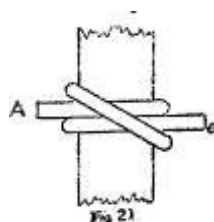

It consists of two similar Half Hitches, the second one placed behind the first:



and it is made in this way when it can be slipped on to the end of the spar.

When the end of the spar is not available – take a half hitch round the spar, and note whether the running end is on top or below:

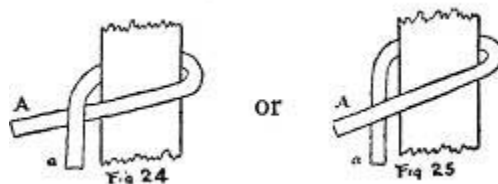

Hold this hitch out of the way with one hand, while another similar hitch is made,

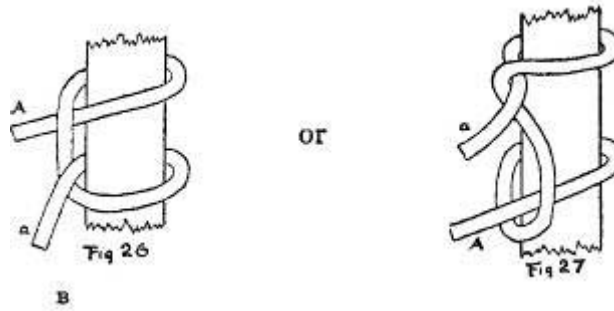

quite separately, in the first case below the other, in the second above.

Similarly with a horizontal spar, if the running end of the first hitch comes off on the right, the second must be made on the left, and vice versa.

**THE BOWLINE**

A BOWLINE is a loop that cannot slip; made at the end of a rope:



Two methods of tying it – first, the simplest – Figures 29 to 32 explain themselves:

Second, the quickest:

Take the rope in both hands, as shown in Figure 33, thumbs on top, the length of rope between the hands being the size of loop required.

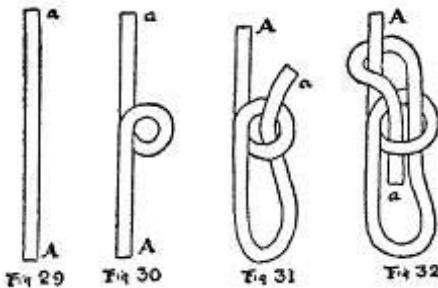

Place running end on standing part, and

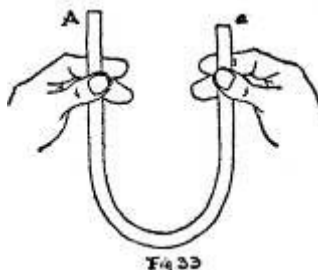

hold both in right hand, thumb down, finger on top.

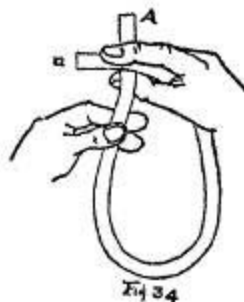

Twist inwards towards the body, with the right hand, making a loop with the standing part, and bringing the running end up inside it; steady it with the left hand. Both thumbs now on top.

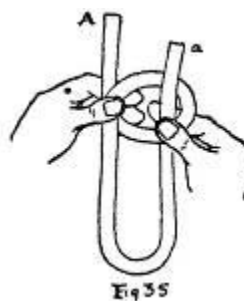

Hold the loop with the left hand. Take the end of the running part with the right hand, and pass it over the loop, under and behind the standing part, and down through the loop.

#### **FISHERMAN'S KNOT**

THE FISHERMAN'S KNOT should not be confused with Fisherman's Hitch.

USE: For tying together two wet or slippery lines.



With the running end of each line tie a thumb knot round the other. Then pull together. Note that the thumb knots must both be tied so that the running ends are alongside the standing ends, as in the Reef Knot. If not, the knot will not pull up fair. Figure 38 is right, Figure 39 wrong:

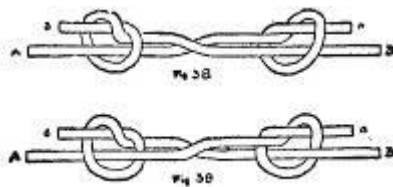

**THE SHEEPHANK**

USE: To shorten a rope, or to strengthen a weak part when there will be a continuous strain on the rope.

Measure how much you want to take up, and lay this portion into three:

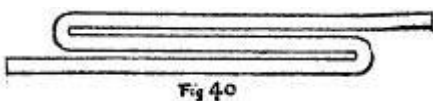

With each standing part take a half hitch round the corresponding bight.

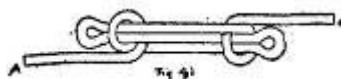

**CHAPTER III**

**MORE ABOUT THE TENDERFOOT KNOTS**

**THE REEF**

THERE are three bad varieties of the Reef;

- a. The Granny, already illustrated.
- b. The False Reef, or Thief:



- c. The False Granny :



There are two good varieties:

- a. The Single Bow:

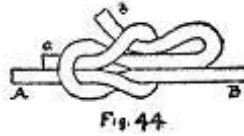

b. The Double Bow:



A Reef Knot may be undone, or "broken," by pulling one of the running ends at right angles to the ropes:

The result is a "lark's head," which comes undone very easily;

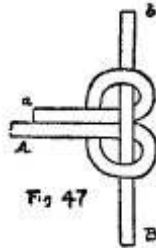

If a Granny is broken the result is a Clove Hitch:

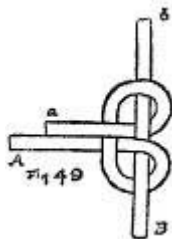
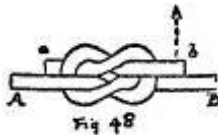

#### **THE SHEET BEND**

If the ropes are very unequal in thickness, or wet, a Double Sheet Bend should be used. Begin as for the Single Sheet Bend; after passing the thinner rope round the back of the loop, take a second turn round the back and under itself, before running it downwards under itself:

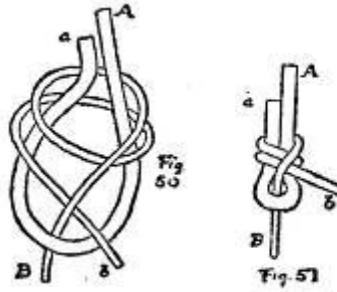

Note that if a Sheet Bend is broken by straightening out the loop the Hitch becomes a Slip Knot:

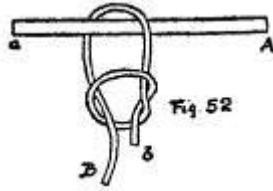

A form of the Sheet Bend, known as the Weaver's Knot, is used very largely in certain trades. It has the advantage of being very quickly tied, and of bringing the ends together so that they can be cut off with one snip, but it is not so suitable for use with a rope as the form already given, where the ends come off on different sides.

Cross the ends:

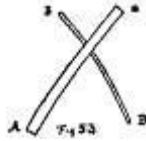

Take a bight of B below the cross and place it over A and under its own end:

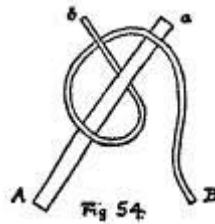

Pass the end of A over two turns of B and under one.

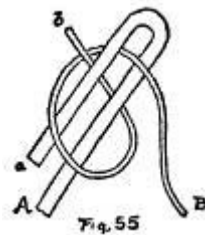

Tighten up knot by pulling on “standing part” of B.

**THE CLOVE HITCH**

A Clove Hitch is not a “give-and-take” knot. The end should be fastened by

- a. A Half Hitch.
- b. Twisting the ends together, as when beginning a lashing.
- c. Seizing the end.

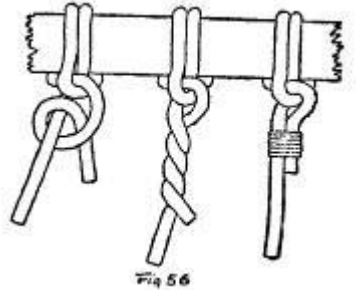

A Clove Hitch may be picked up in the middle of the rope by crossing the hands, each hand picking up a bight, and then each hand turning in the *same* direction. If the right hand is crossed on the top the direction will be counter-clockwise.

This is sometimes called a Farmer’s Hitch.

**THE BOWLINE**

To tie a Bowline with the loop away from you, as over a holdfast, or round another person’s waist:

Pass round right to left:



Twist once, starting with the running end in front of the standing part:

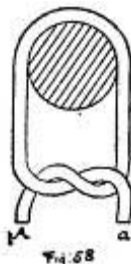

Take the ends in the two hands, and give a sharp pull on the running end with the right hand. This will straighten it, and form a loop on the standing part:



Hold the standing part with the left hand,



and pass the running end under it, left to right, and down through the loop.

The Running Bowline is useful as a running noose, for example, as an extempore lariat.

Form a loop with a long end, running end under standing part:

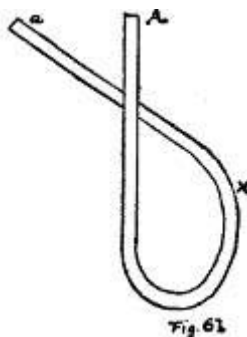

Turn the running end back over the standing part, and tie a Bowline at X:

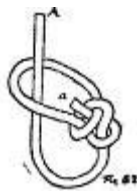

The Bowline on a bight forms a double loop, and is useful for such purposes as slinging a person.

Use a long bight of the rope, and start making an ordinary Bowline with the bight:



Open out the bight, pass the whole knot through it, and pull taut:



**THE FISHERMAN'S KNOT**

This can be strengthened by taking one or more turns, and then passing the running end under the turns. Figure 65 shows this done with one turn, and gives half the knot only:



**THE SHEEPSHANK**

A Sheepshank may be picked up by making three similar half hitches slightly overlapping each other:

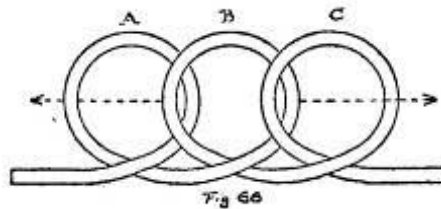

Then pull out the sides of the centre one as indicated by the dotted arrows.

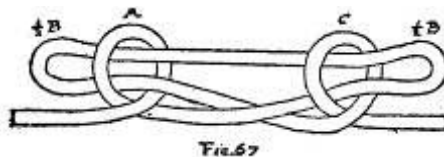

If the rope in which the Sheepshank is tied is to be allowed to become slack it is advisable to seize the bights:



If one end of the rope is available a very firm hitch may be made with both ends passing through the loops. First make a half hitch at the end of the part marked for shortening, nearest the standing end. Then pass the running end through the half hitch, round the standing end, and back through the half hitch:



Complete at the other end of the shortening in the usual way, finally passing running end through its own loop:



## CHAPTER IV SIX HITCHES

### 1. ROUND TURN AND TWO HALF HITCHES,

For securing a rope to a holdfast. If the hitch is to remain for some time the end should be "stopped," or seized down with a piece of string or light line. See Figure 71.

It is important to note that the two Half Hitches should be made exactly similar; that is, if the running end passes first over and then under the standing part in the first Half Hitch, it should do the same in the second. In fact they form a Clove Hitch.

If the running end is long, as often happens in making off a rope, this knot may be tied with a long bight of the rope. See Figure 72.

### 2. FISHERMAN'S HITCH, OR FISHERMAN'S BEND.

A very similar knot, used chiefly for making fast to an anchor, or to a bucket for dipping over-side.

In this case the first Half Hitch picks up the round turn as well as going round the standing part. The second is an ordinary one. See Figure 73.

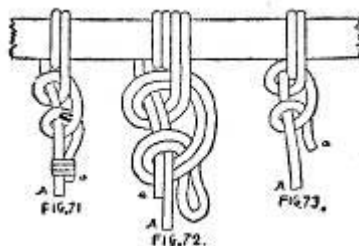

### 3. TIMBER HITCH.

Used for securing the end of a rope to a spar or package. Pass the rope round the spar, make a Half Hitch round the standing part, and twist round several times in the same direction as the Half Hitch.

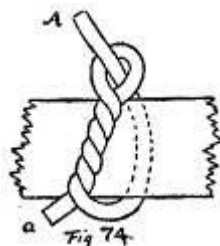

Useful with a Half Hitch for towing spars.

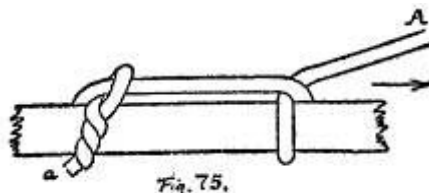

### 4. DRAW HITCH, or HIGHWAYMAN'S HITCH.

A “give-and-take” Hitch, which can be broken by a single pull at the running end. Useful to tie in any place where it is desirable to untie quickly; such as the painter of a boat to a ring; or for coming down a tree by a rope, where the running end is left long enough to be twitched from the ground – only don't try to come down the running end by mistake!

Take a bight, and pass behind the holdfast bight at top. See Figure 76.

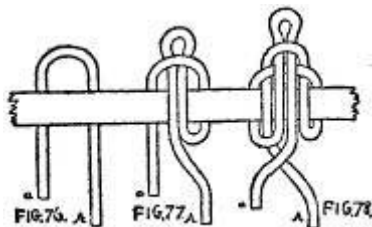

Take a bight of the standing part, and pass in front of the holdfast, and through the first loop. Pull up. See Figure 77.

Now take a bight of the running end, and pass through the second loop, also in front of the holdfast. Pull up. See Figures 78 and 79.

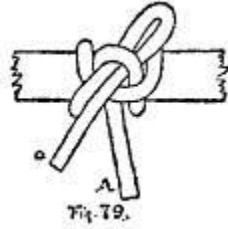

5. MAGNUS HITCH.

To make fast a rope to a round spar, when much friction is required to prevent slipping.  
A round turn on one side, and a Half Hitch on the other:

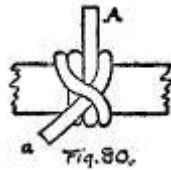

6. ROLLING HITCH.

Somewhat similar to a Clove Hitch, but less likely to slip under a sideways pull. Useful for attaching a rope to another rope which has a strain on it.

Start with a Half Hitch, as in Figure 81. Then take a round turn, round standing part and larger rope, as in Figure 82.

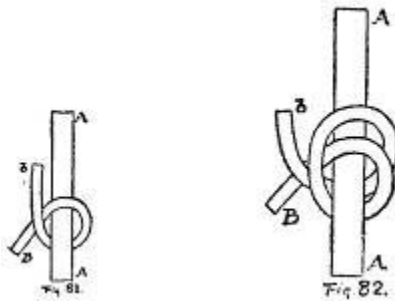

Then a Half Hitch on top similar to the first one, as in Figure 83. To make doubly sure, twist the running end round the fixed rope, in the opposite direction to that in which the hitches have been made, and stop it down. See Figure 84.

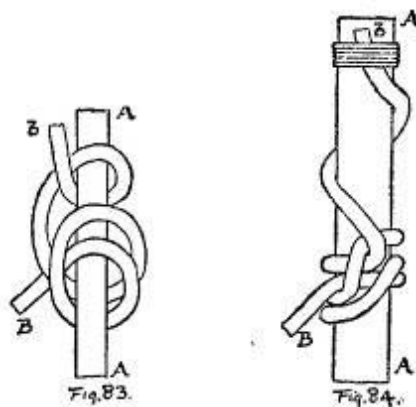

**CHAPTER V**  
**SIX MORE HITCHES**

1. MAN HARNESS HITCH.

To make a loop in the middle of a tow rope, which will not slip, so that a Scout towing may put it over his shoulder and add his weight.

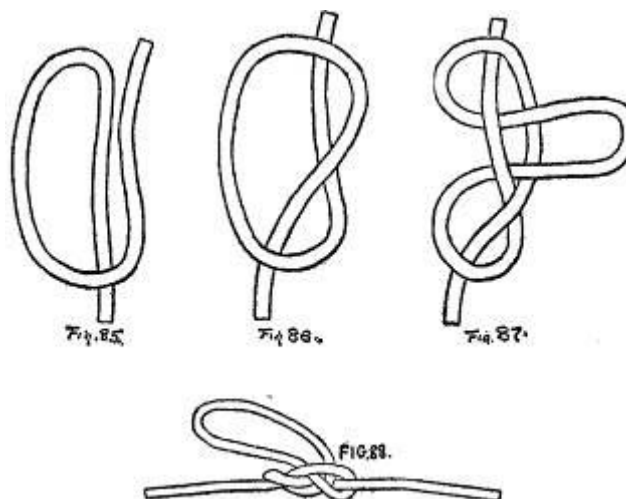

This hitch is best made by laying the rope on the ground; it can also be done by holding the loops over the hand. Figures 85 to 88 explain themselves.

The Middleman's Knot produces a somewhat similar result. It is made on the principle of the Fisherman's Knot.

Take a bight of the rope, make a Half Hitch in one side, and slip the bight through:



Then make a Half Hitch on the other side, further from the bight than the first, and slip the whole knot through this:



The completed knot:

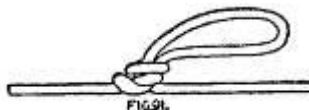

2. CATSPA W.

Used to make a temporary loop in a rope for hooking on the block of a tackle.

Take a bight of the rope, and turn it back, forming two loops. See Figure 92.

Take a loop in either hand, and twist outwards opposite ways. See Figure 93. Place the two loops on the hook of the block.

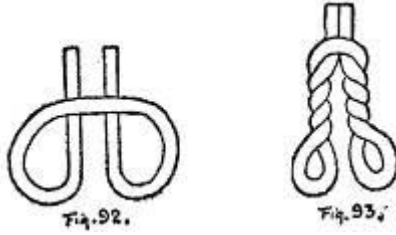

**3. BLACKWALL HITCH.**

For hooking a rope to a block. Figure 94.



It may be strengthened by taking a turn round the neck of the hook first. The ropes should cross each other behind the hook, standing part on top, as in Figure 95.

This is called a Double Blackwall Hitch.



If the rope is greasy, make a Blackwall, and take a bight of the running part behind the point where it crosses, and bring it over the standing part and on to the hook of the block. This is called a Midshipman's Hitch.



**4. LEVER HITCH.**

For temporarily attaching a spar to a rope, so as to obtain a great pulling strain on it. It is really a Thumb Knot, with the spar thrust through:

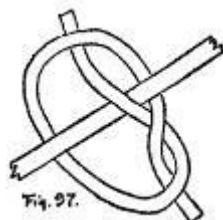

5. CHAIR HITCH.

A hitch which can be made in the middle of a rope, and which provides two loops, one to go under the shoulders of an unconscious person, the other under his knees, so that he may be safely lowered from a height.

Start with two Half Hitches, as for the Clove Hitch, but lay them together simply, and not interlaced.

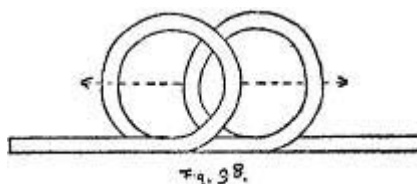

Pull the inner sides of the hitches outwards, as shown in the figure, into two loops, one about two and a half feet long, the other about three and a half feet.



Now take a Half Hitch over each loop, as is done in the Sheepshank:

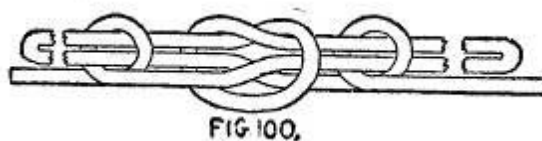

And the result is as shown in Figure 101.

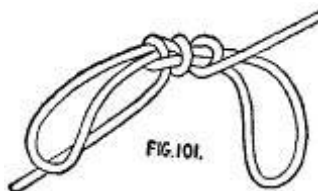

6. HALTER HITCH.

An easily broken hitch for tying up the head-ropes of a horse. It explains itself:

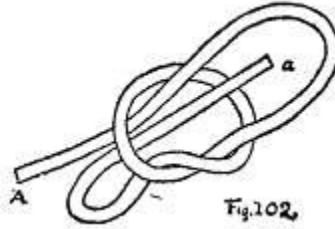

## CHAPTER VI

### SOME SPECIAL KNOTS

#### 1. THE BINDER TURN.

A useful method of bending two lines together if the knot has to pass through machinery as both running ends point in the same direction. It is really a Sheet Bend, with the running end of B put through the reverse way:

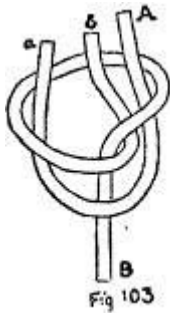

#### 2. THE LARIAT KNOT. A well-balanced loop, to act as an emergency hondu for a lariat.

Make a Thumb Knot, push up the standing part, and insert the running end, which should be finished with a small Stopper Knot to prevent slipping:



#### 3. THE GUY-LINE HITCH.

Very useful for an extemporised Guy-Line; it can be lengthened or shortened as required.

Make two Thumb Knots a little distance apart, and some way up the rope. Pass the running end through them, *towards* the loop.

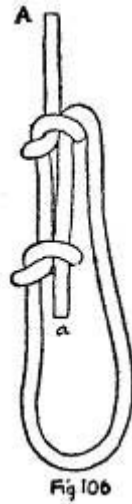

4. HAWSER AND CARRICK BENDS.

Methods of bending large ropes together. The Figures explain themselves:



5. LARK'S HEAD.

The Lark's Head is simply the Reef Knot broken. One of its special uses is for girthing up a horse, or fastening a belt, when brass loops and a raw hide or leather thong are used instead of buckles; in these cases it is generally called a Latigo Lash.

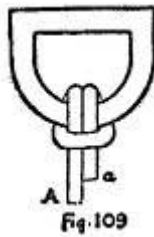

You can use a succession of Lark's Heads to cover an ugly iron ring – it really comes to putting on Half Hitches alternately over and under the ring:

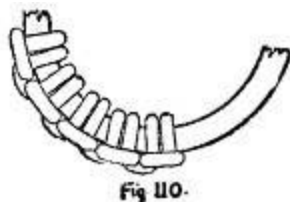

6. THE SURGEON'S KNOT.

Used for tying up arteries during an operation. It is merely the Reef Knot with an extra twist:



## CHAPTER VII

### SIX STOPPER KNOTS

STOPPER KNOTS are used to finish off the ends of ropes permanently and neatly. In the diagrams 3-strand rope is used, but 4-strand can be tied in a similar manner. The knots are all made in the same sort of way, by un-stranding a portion of the rope, forming a loop with each strand, and interlacing the ends – the difference between them lying in the method of interlacing. They may be finished off by tucking in the ends, or by bringing them together at the top, or by seizing and cutting off short. If it is desired to tie a Stopper Knot in the middle of a rope, unstrand carefully to the place, tie the knot, and strand up again above it. They may be tied either right handed or left handed.

1. THE WALL KNOT.

Make a loop with one strand (a), its running end going under strand b (Figure 112). Then make a loop with b, its running end passing under a and c (Figure 113). Lastly make a loop with c, the running end passing under a's standing part, and over a's running part (Figure 114). Figure 115 is the completed knot. Figure 116, one way of finishing it off. Note that each strand goes under the standing part of the next one to it, and up through its loop:

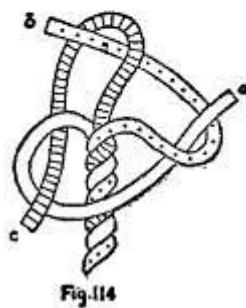
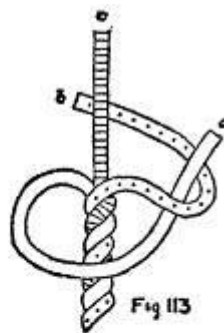
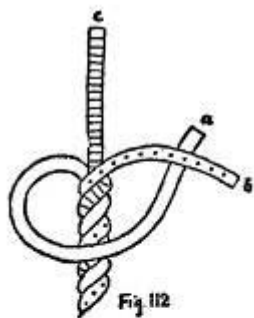

The knot may be doubled by following round again, each strand eventually coming up through its own loop:



## 2. THE DIAMOND KNOT.

In this case each strand goes under both standing and running side of the next loop to it, and the standing side of the third loop, coming up through the third loop:

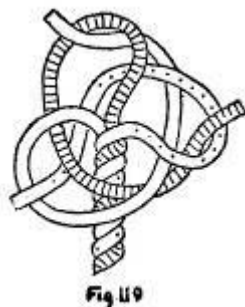

The knot may be doubled:



Fig 121

3. THE MATTHEW WALKER KNOT.

In this knot each strand goes up through the second loop, and then up through the third loop – or, under standing part and over running part of second, under standing part of third and up:

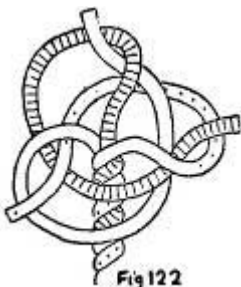

Fig 122



Fig 123

4. THE DOUBLE MATTHEW WALKER.

This is really a different knot, and not a double. Each strand goes up through second loop, up through third, and then up through its own:

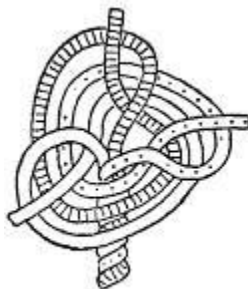

Fig 124



Fig 125

5. THE CROWN KNOT.

This is the reverse of the Wall Knot, Each strand goes over the standing part, and under the running part, of the next loop:

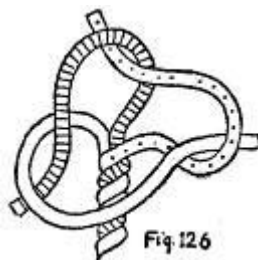

Fig.126



Fig. 127

6. THE TURK'S HEAD, OR MANROPE KNOT.

Tie first a Wall Knot, than a Crown Knot, then double the Wall, and then the Crown.



The Turk's Head may also be tied with a single strand, as a ring, or woggle, with either four or five loops. The principle of the interlacing is shown in Figures 129 and 130:

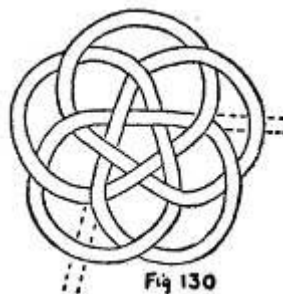
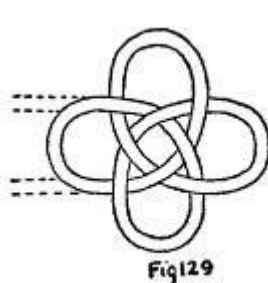

To tie a 4-loop woggle on the flat: First make a Thumb Knot at the standing end, standing end on top on left:

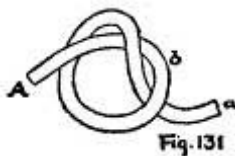

Then take b and pull it out into a loop, twisting it over, standing part on top:

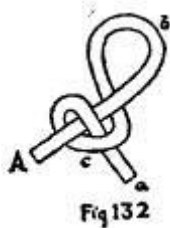

Next pull out a loop at c, and pass it behind underneath, and up through loop b:

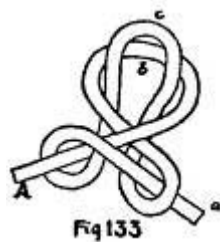

Lastly, pass end a through loop c from front to back:

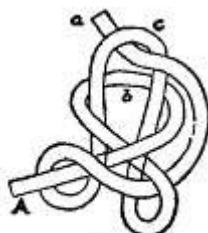

Fig 134

A little manipulation will bring it to the same shape as in Figure 129. Open out the middle so that it forms a ring, and follow round the course of A with a second, or a second and third turn, being careful to keep always on the same side of the previous returns. Cut the ends short, and sew together underneath. A completed 4-loop woggle with two returns is shown in Figure 135.



Fig. 135

To tie a woggle round a stick, or two fingers of the left hand: First turn cord round twice:



Fig 136

Then pass *a* under the right-hand return, from left to right:

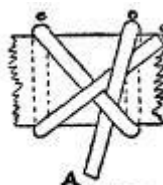

Fig 137

Now turn the work over a bit, cross the two returns, right (b) under left (c), and slip (a) through, over the left return (c, now on the right) and under the right one (b, now on the left).

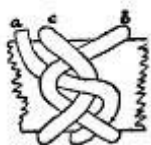
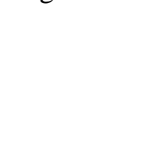
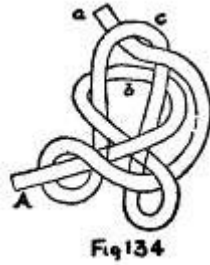

Fig. 138

Figure 139 shows the crosses all pushed together so that they can be checked:





To make this into a 5-loop woggle bring up a between the two returns b and c, and repeat the former process – a under right return, left to right; cross right return under left; pass a over and under:

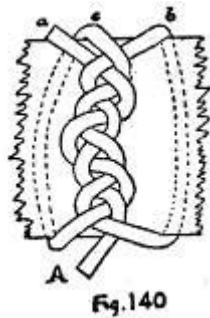

## CHAPTER VIII

### SIX PLAITS

#### 1. FLAT PLAIT, OR SENNIT.

(a) This is a simple matter of interlacing strands, and may be done with any number of strands. Figures 141, 142, and 143 show the method, and Figures 144, 145, and 146 the result, for three-, four- and five-strand ropes respectively:

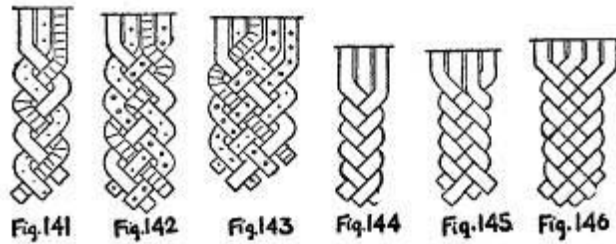

(b) If the interlacing passes over more than one strand at a time a different effect is produced. Figures 147 and 148 give an example with five strands.

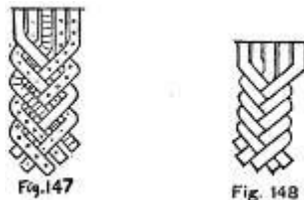

(c) A plait with one strand may be made in various ways. The Chain Plait is started as in Figure 149, and continued by passing a bight of the running end through the loop, pulling up, and repeating the process with the loop thus formed;



The Double Chain starts by forming a double loop, Figure 151, and is then continued by interweaving the running end.

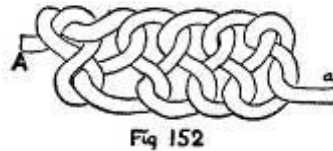
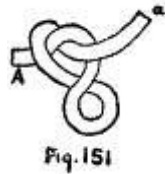

**2. THE LARIAT PLAIT.**

A flexible round plait, generally called the Lariat Plait, can be made with four strands. There are three motions: First cross c over b, then bring d behind b and c, then bring d across c and behind b and c. Repeat the process with a, the left hand strand, and then alternately with the right and left hand strands:

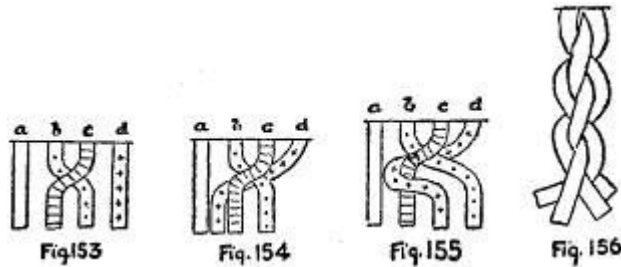

**3. FLAT ON ONE SIDE, ROUND ON THE OTHER.**

Six strands, interlaced as in Figure 157, each outside strand in turn going behind three and back in front of one.

The appearance of one side is that of the Lariat Plait (Figure 156) and of the other the Flat Plait, illustrated in Figure 148:

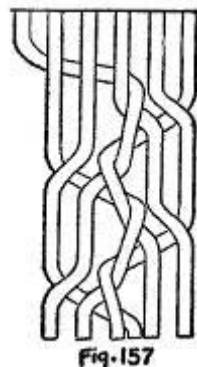

4. SQUARE PLAIT.

Eight strands, interlaced as in Figure 158. Each outside strand in turn goes behind five and back in front of two.

Appearance, on all four sides, as in Figure 148:

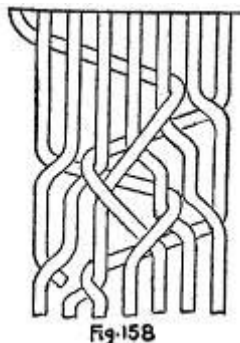

5. BOATSWAIN'S PLAIT,

This is made by tying Reef Knots round another rope or a rod. The Reef Knots are tied half on one side of the rope and half on the other; one strand passes continually across the back of the rope, the other across the front:

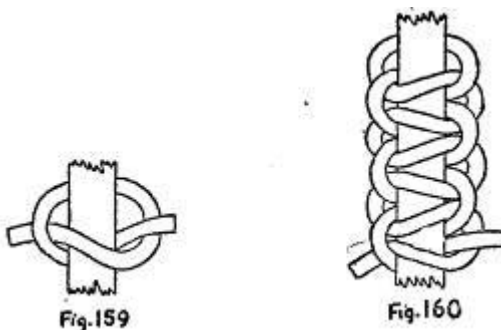

If Grannies are tied the result is a spiral. In this case each strand goes round the rope.

6. CROWN KNOT PLAIT.

This Plait consists of a series of Crown Knots, which were described in a previous yarn, and may be tied either by itself or round another rope as a core, and any number of strands may be used. To get a good effect round another rope the sum of the diameters of the strands should be about twice the diameter of the core.



If the knots are tied all right- or all left-handed they produce a spiral:



Fig.162

If they are tied alternately right- and left-handed the effect is vertical:



Fig.163

## CHAPTER IX

### SPLICING

THE Short Splice is a method of permanently joining the ends of two ropes of equal size. The joint is somewhat thicker than the rope, so it cannot be used in cases where the rope will be required to run through the sheave of a block.

Unstrand the ends of both ropes for a distance equal to about twice the circumference of the rope, and “marry” them, that is, lay them together, end to end, with the strand interlaced alternately.

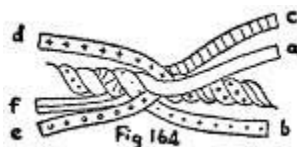

Fig 164

Now take the middle strand of one rope – in this case d – and pass it over the strand of the other on which it is resting – c – and tuck it under the next one on the left – b – working against the lay of the rope.

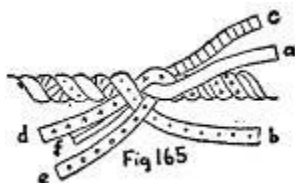
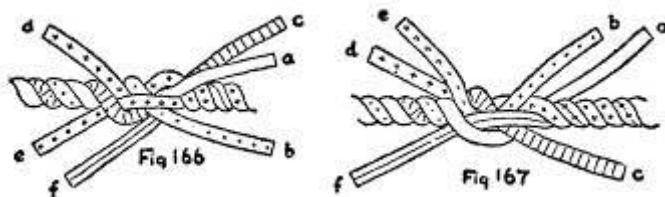

Fig 165

Then similarly pass a over b and under c, and f over c and under a, turning the work round a little each time.



Now start with the strands of the other rope, and deal with them in a similar way, each going over one and under the next strand, always working against the lay.

Repeat the process again at each end, cut the ends off short, and roll the splice under your foot on something hard.



Your interlacing can be checked at the end of each stage by seeing that the ends come out alternately with the strands they are interlacing.

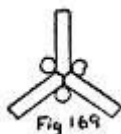

In a splice on a heavy rope it is advisable to put temporary whippings on the strands, and to tie a piece of rope round the two ropes where they marry to hold them steady while working. The splice may be made neater by cutting away half of each strand after the first interlacing.

A well made short splice does not detract materially from the strength of the rope.

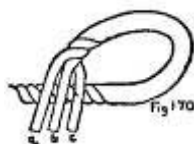

An Eye Splice is made on the same principle as the Short Splice.

Unstrand a few inches of the rope, and lay the unstranded portion back on the rope at a suitable distance to form the required eye, bending the rope so that the loose strands lie across the lay of the rope.

Take the middle strand – b – and tuck it under the strand it lies on, from right to left, that is, against the lay.

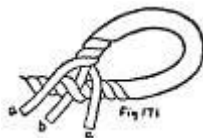

Now take the next strand on the right—c— cross it over b and the strand under which b is tucked, and tuck it under the strand next on the left, again against the lay.

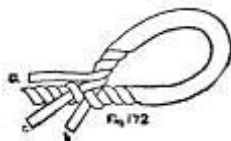

Next turn the work over.

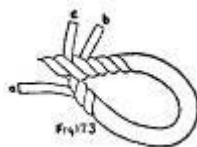

Lastly take the remaining strand – a – and tuck it under the strand which has not been used yet, from *right to left*.

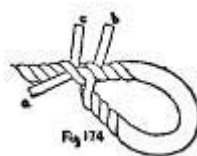

You should then have strands alternating correctly, and can continue and finish off as in the Short Splice.

An Eye Splice well made is as strong as a seized Bend, and stronger than a Clove Hitch.

#### BACK SPLICE.

A method of pointing a rope.

Begin with a Crown Knot (see Chapter VI).



Then pass each strand in turn, from left to right, that is, against the lay, over one strand and under one. It will be noted that each strand passes under itself.

Repeat the process, and finish off as in the Short Splice.



#### CUT SPLICE.

To make a loop in a rope,

Lay the portions of the rope together after unstranding each, the overlap of the unstranded portion being the length of the Cut Splice required. Be careful to arrange them so that the

loose strands of one portion lie across the lay of the other portion. Then proceed exactly as in an Eye Splice.

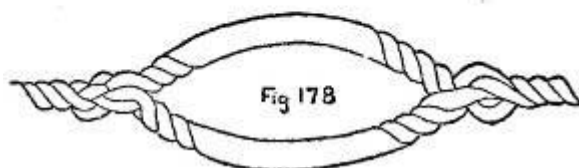
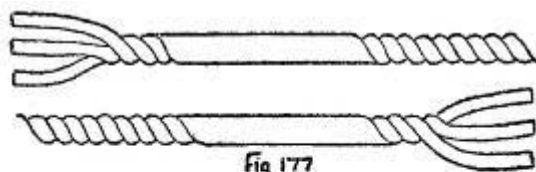

LONG SPLICE.

If a splice is required to pass round the sheave of a block a Long Splice must be used.

Unlay both ropes, to a length equal to seven times their circumference, and marry the ends as has already been described.

Now select one strand of each rope, choosing two that come opposite each other, and twist them loosely together to get them temporarily out of the way.

Then unstrand one strand of one of the ropes further, replacing it carefully by the corresponding strand of the other rope, to within two or three inches of its end. Twist these together. Then do the same on the other side. The result is shown in Figure 179.



Now take each pair of loose strands in turn, cut away one half of each, tie together with one twist, pass over one strand and under one strand twice, on opposite sides of the knot, and cut off.

It is found by experience that a long splice weakens the rope from 5 to 40 per cent.

A ROPE QUOIT OR A GROMMET

Is made by taking one strand out of a rope as long as about three and a half times the circumference of the quoit required. The strand should be carefully unlayed, so as to keep the turns in it.

Close it up into a ring, and pass the strand round and round in its original lay, until the intervals are filled up. Finish as in the Long Splice.

## CHAPTER X

### BLOCKS AND TACKLES

#### 1. SOME DEFINITIONS.

A Block is a piece of wood or metal containing one or more wheels or pulleys on which a rope can run, called sheaves, and fitted with one or more hooks or eyes for suspension.

Blocks are called single, double, or treble according to the number of sheaves they contain.

A Snatch Block has an opening at one side, so that the bight of a rope can be placed in it.

The rope rove in a tackle is called a *fall*: to *overhaul* it is to separate the blocks, to *round it in* is to bring them nearer together. When completely rounded in the tackle is said to be *chock-a-block*.

The part of the rope between block and block, or between the end of the rope and block, is called a *return*. Thus a single and double tackle – see below – has four returns.

#### 2. POWER.

Theoretically the Power of a tackle is given by the number of returns at the movable block – that is, in the example quoted above, the power would be 3 to 1, Some reduction must however be made for friction.

If one tackle is tailed on to another the powers of the two tackles are multiplied together.

#### 3. SIZES OF ROPES AND BLOCKS.

The size of a rope is its circumference in inches. Its length is generally given in fathoms.

The size of a block is measured by the length of the shell. The rough rule is that the length of the shell is three times the circumference of the largest rope it will take.

#### 4. TYPES OF TACKLE.

Four of the simplest forms of tackle are shown in Figure 180.

1. One single block. No gain.
2. Two single blocks. Two to one. Called Single Whip.
3. Single and Double. Three to one. Called Luff Tackle.
4. Two double. Four to one. Called Gyn Tackle.

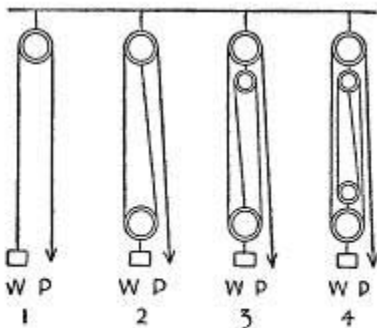

Fig 180

5. LOADS AND POWER REQUIRED.

The load that can be lifted by a tackle depends on the size of the rope used as the fall. A safe working stress for hemp, rope is: double the square of the circumference in inches, to give a stress in hundredweight. Thus a 3-inch rope would have a working stress of  $2 \times 3^2$  cwt, or 18 cwt.

It has been found by experiment that men pulling on a horizontal fall can exert about half their weight. Probably the power exerted by Scouts would be in a smaller proportion – say an average of half a hundredweight each, if they were not too young.

From this we can work out what is required to lift half a ton.

Half ton equals 10 cwt.

Try  $2\frac{1}{2}$  inch rope. The strength by the formula given above is  $2 \times (2\frac{1}{2})^2$ , or  $2 \times (5/2)^2$ , or  $\frac{2 \times 25}{4}$ , or  $12\frac{1}{2}$  cwt, so that this rope is strong enough.

The commonest of the larger tackles is the single and double, or Luff Tackle, giving a power of three to one. Using this the power required is one-third of 10 cwt, or say  $3\frac{1}{2}$  cwt. Therefore, at half a hundredweight each, seven Scouts should lift half a ton – eight would probably be safer.

6. STROPS OR SLINGS.

To fasten the hook of a block to a spar, or to a cable which is too thick to pass into it conveniently, a strop or sling should be used. This consists of a ring of rope, with a diameter of three to four feet, and may be made from a piece of rope whose ends are joined by a short splice, or by laying up 10 or 12 or more returns of some soft line such as spunyarn, and holding the returns together by half hitches of the same line at intervals at about three to four inches, in which latter case it is called a Selvagee.

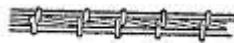

Fig 181

The methods of use are fairly obvious. The strop should always be used on the double, that is, after passing twice round the spar, both loops should be inserted in the hook of the block.

## CHAPTER XI

### LASHINGS

1. LASHINGS are short lengths of light rope used for tying spars together, and for other miscellaneous purposes. The size of the rope depends on the work required – for light work such as Scouts would require 1-inch rope is sufficiently strong for the purposes, and  $\frac{3}{4}$ -inch will suffice for most. A suitable length is twelve to eighteen feet. The ends should be whipped.

Care should be taken of lashings when not in use. A good way to roll them up is to turn round thumb and elbow of left hand into a hank, and then take a Half Hitch with the end of the lashing round one end of the hank, passing the end back through the loops. In the illustration (Fig. 182) two turns only of the hank are shown, for clearness.

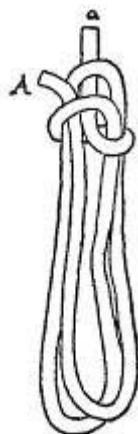

Fig. 182

## 2. THE SQUARE LASHING.

This is the most widely used lashing for securing one spar to another, when they cross each other at right angles, or nearly so.

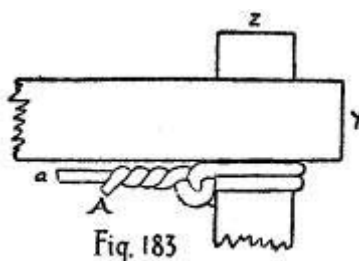

Fig. 183

Start with a Clove Hitch round the upright spar (Z) immediately below the spot where the horizontal spar (Y) will cross it. Twist the running end round the standing end, so that the friction against the spars will hold it firm.

Now pass the lashing in front of and over spar Y, behind spar Z above spar Y, down again in front of spar Y on the other side of spar Z, and behind spar Z again below spar Y.

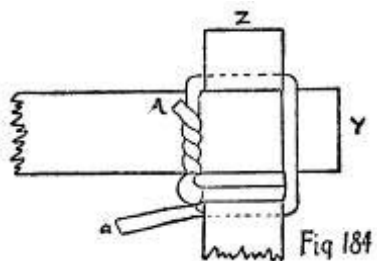
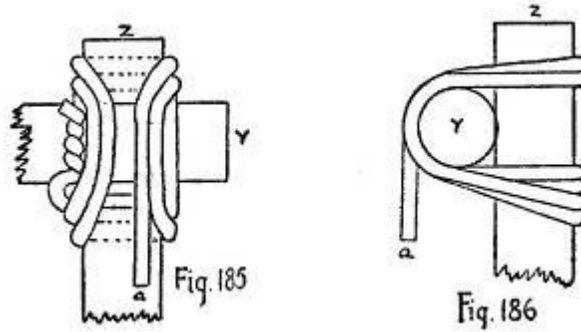
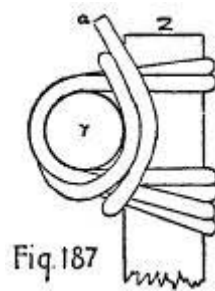

Fig 184

This is one complete turn, and we require three or four like it. Follow therefore the same procedure again, and, in order that the turns may lie flat, make them either inside the previous turns on spar Y and outside them on spar Z, as shown in Figure 185, or the reverse, outside on spar Y and inside on spar Z.



Now comes the last stage, called frapping. The lashing is passed completely round between the spars, and over the first returns several times, to draw the whole firmly together.



This needs tight work, and while one Scout pulls hard on the end of the lashing, another beats in the returns at each corner with frapping mallet (Fig. 188).

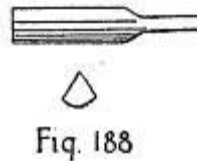

The lashing should be finished off with a Clove Hitch round the outside of spar Y. And be careful to arrange your Clove Hitch so that it cannot slip round and loosen the lashing.

### 3. DIAGONAL LASHING.

This is used to lash together two spars which from their position tend to spring apart.

Begin with a Timber Hitch round both spars, drawing them together, then take three or four turns round each fork, then frap, and finish with a Clove Hitch.

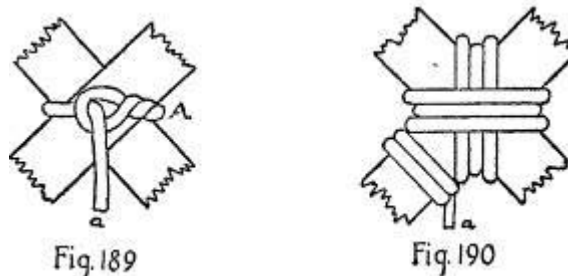

4. SHEAR LASHING, OR ROUND LASHING.

Used for lashing together two parallel spars, or two spars which will be opened slightly out of the parallel to form Shear legs.

Start with a Clove Hitch round one spar and twist the running end round the standing end. Take seven or eight turns round both spars, then a couple of frapping turns, and finish with a Clove Hitch round one spar. If the spars are close fitting a small piece of wood should be placed between them to keep them slightly apart, otherwise difficulty will be experienced in inserting the frapping turns.

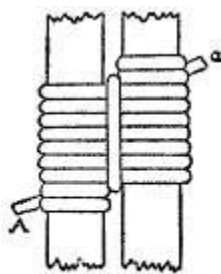

Fig. 191

5. FIGURE-OF-EIGHT LASHING.

For lashing the tops of three poles together to make a Gyn, or Tripod.

Lay the spars alongside each other, start with a Clove Hitch round one of the outside spars, twist the running end round the standing end, and give six or eight turns round the spars working under and over alternately, like a figure-of-eight. Frap between each spar, and finish with a Clove Hitch.

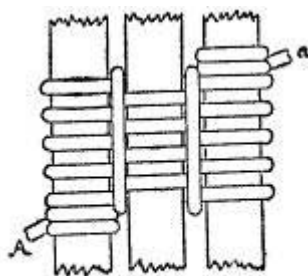

Fig. 192

6. TO LASH A BLOCK TO A SPAR.

Begin with a Clove Hitch round the spar above the block, then two or three turns round spar and hook of block, lastly two Half Hitches round the spar below the block.

## CHAPTER XII

### LIFTING WEIGHTS

1. To lift a weight by means of a tackle, and still more to move it sideways, it is necessary to have a support above the weight to which the tackle may be fixed. Such a support may be available in the shape of a mast, or a tree; if not one must be made by spars.

The technical names for such supports are a Derrick where one spar is used, Shears when two are used, and a Gyn when three are used.

2. A *Standing Derrick* is a single spar with the butt on the ground, and the tip held steady by guy-ropes, of which there should be four, equally distributed. The uppermost block of the tackle is lashed to the spar just below the guy-ropes. If more than two or three Scouts are required to haul on the fall it should be led through a block at the foot of the spar so as to obtain a horizontal pull.

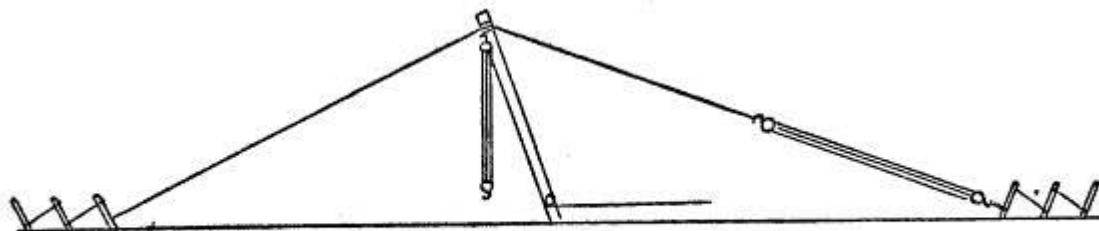

Fig. 193

The guys should be fastened to the tip of the spar by Clove Hitches with the ends seized.

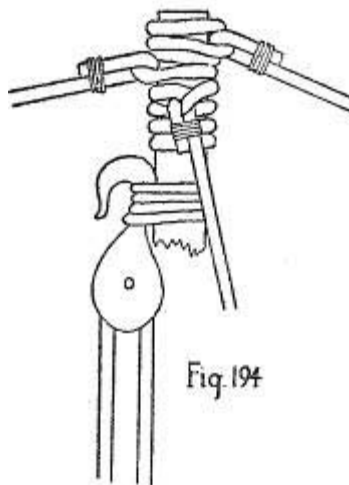

Fig. 194

Holdfasts will be required for the lower ends of the guys, and if the spar is heavy tackles will be needed in them – the distance of the holdfasts from the butt should be twice the length of the spar. The butt of the spar must be prevented from slipping by insertion in a hole, or by lashing to a holdfast; if the ground is very soft a short cross-piece lashed on will prevent it from slipping.

A Standing Derrick will provide a vertical lift, and can be used for a small horizontal movement by letting the derrick fall out of the vertical; the machine is safe up to an inclination of three to one, but care must be taken to approach this gradually as the guys are apt to stretch.

In calculating the length of spar needed it must be remembered that the tackle, even when chock-a-block, will occupy about four to five feet of the available height.

### 3. SWINGING DERRICK.

This machine consists of a Standing Derrick with a swinging arm attached to it near its foot. It gives a considerable horizontal movement by swinging the arm by means of two light lines, and is particularly suited for use on a river bank or quay for unloading weights from a boat. In such a case, as guys cannot be taken into the water, two spars must be used as struts instead of one of the guys, each about half as long again as the upright spar.

The swinging arm is best made by lashing two light spars together, touching each other at the tip, and separated at the butt by a small cross-piece; this cross-piece and the ends of the butts then fit round the vertical spar.

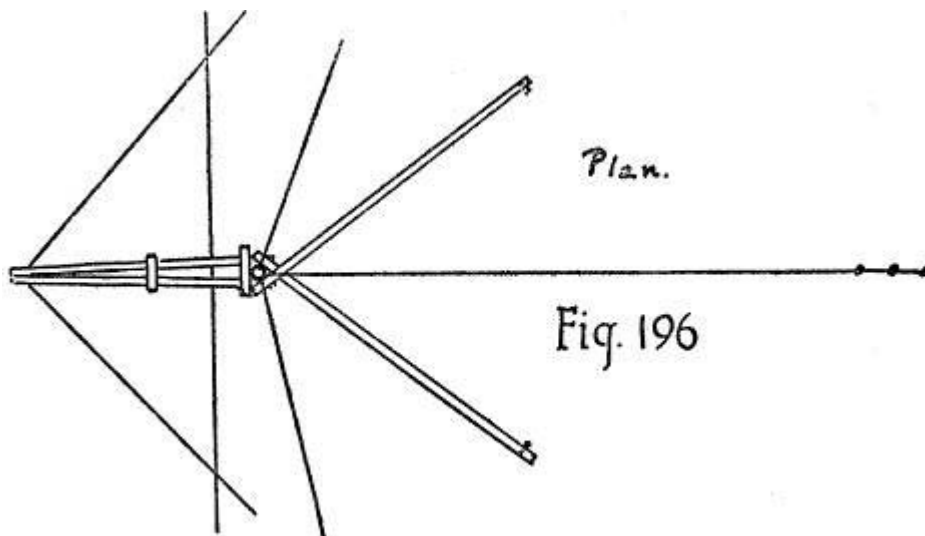
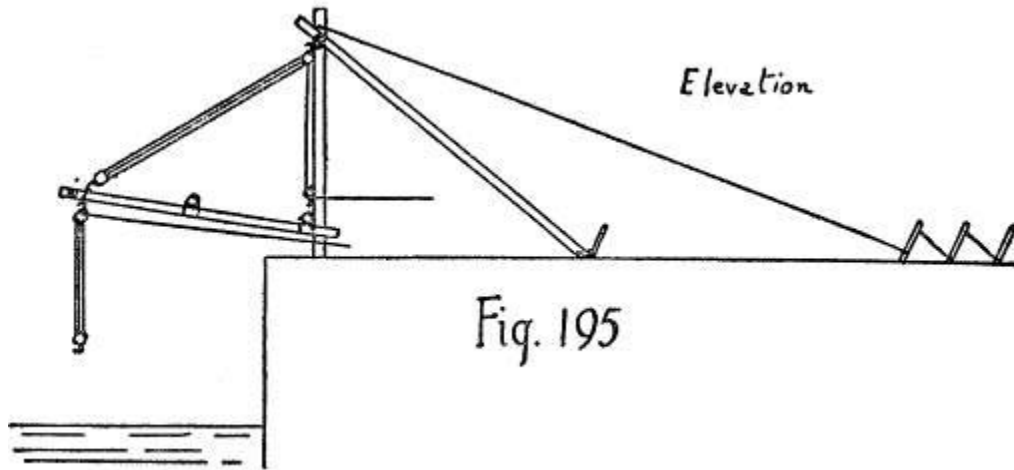

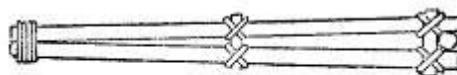

Fig. 197

The butts of the swinging arm are held up on the vertical spar by a stout piece of rope whose centre is lashed to the vertical spar by a Clove Hitch, and whose ends are lashed to the two spars of the swinging arm. If the Clove Hitch shows a tendency to slip down it may be held in place by another rope fastened below it by a Clove Hitch and above it by twisting round the vertical spar several times and stopping down, as in the Rolling Hitch (Chapter IV, 6).

The tackle at the head of the upright spar is fixed to the tip of the swinging arm, and serves to raise or lower it. Another tackle is fixed to the tip of the swinging arm to lift the weight.

#### 4. SHEARS.

Shears consist of two equal spars lashed together at the tips by a shear lashing (Chapter XI, 4), and then opened out at the butts which are held by a cross-piece lashed on to them both. Only two guys are required, fore and aft, and the shears can be inclined by easing one and taking up the other, so as to move the weight, but only in a horizontal line.

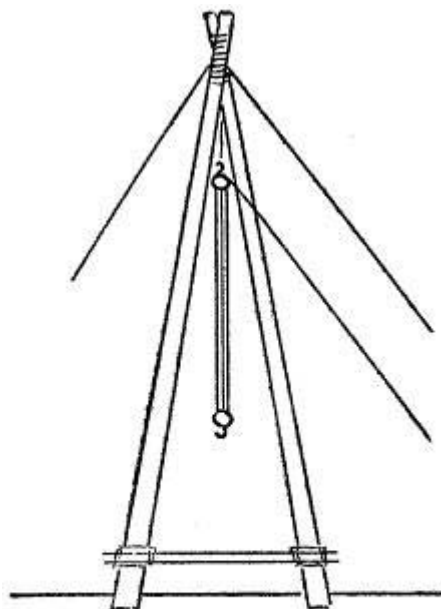

Fig. 198

The distance apart of the butts should be about one-third the length of the spars from butt to lashing; the feet will require holdfasts, and the guys holdfasts and, in the case of heavy shears, tackles, as in the Standing Derrick.

#### 5. GYNS.

A Gyn is made from three similar spars, joined together at the tips by a figure-of-eight lashing (Chapter XI, 5). The legs should be about half their height apart, and should be

secured by lashing on light horizontal spars near the butt. No guys are required, but the weight cannot be moved laterally.

6. PRECAUTIONS.

- (a). Attach light lines to weight to steady it.
- (b). Grease all blocks.
- (c). Mouse all blocks.
- (d). All Scouts at work to keep clear of possible falls of spar or tackle or weight due to breakages.
- (e). When hauling on a fall, or easing off, movement to be steady, and by word of command.

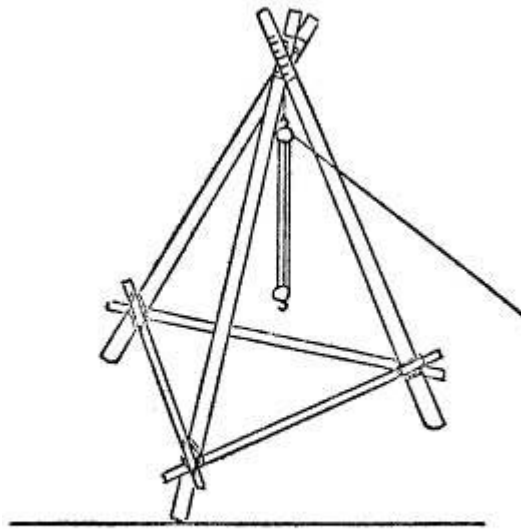

Fig 199

(f). Scouts carrying spars should be sized, and arranged on opposite sides of the spar, closer together at the butt. Lift and move and lower by word of command, butt being lifted last and lowered first.

(g). Ensure good holdfasts, and careful knots for making off to them. The round turn and two Half Hitches (Chapter V, 1) is a satisfactory knot to use. While the machine is in use a Scout should watch each holdfast to give timely warning of any weakness.

(h). Silence of the working party, and a single responsible foreman, are essential.

## CHAPTER XIII

### HOLDFASTS

1. IT is frequently necessary to provide a firm point to which may be fastened the end of a rope which has to take a strain. These firm points are called Holdfasts. A stout tree cannot be bettered, and should be used whenever available, but often one must provide a Holdfast. In designing a Holdfast two things must be considered – first it must be so securely fixed that it will not pull out of the ground, and secondly it must be stout enough not to be broken.

#### 2. THREE-TWO-ONE HOLDFAST,

The handiest form of temporary Holdfast is known as a Three-two-one Holdfast. It is made of rough pickets, about four feet long and two to three inches in diameter: if they are to be used several times the tops should be bound with wire or an iron band shrunk on to prevent splitting.

The second condition, that of stoutness, is provided for by using three pickets in the front group, two in the second, and one in the third – whence the name. The pickets to be driven close alongside each other in each group, and treated as one for lashing. Of course if the pickets are extra stout this multiplication is unnecessary.

The first condition is fulfilled by tying back the top of each group to the bottom of the one behind it, since a picket properly driven generally pulls out of the ground by being upset, and not by the point pulling through. The groups should be placed in accurate line with the strain, and spaced so that the lashing from the top of one to the bottom of the next is nearly at right angles to them both. Like tent pegs they should of course be driven with a slope backwards against the strain.

The lashings between the groups start with a Clove Hitch round one group, then pass round and round the two several times, and finally are secured by two or three Half Hitches round the returns. If they appear loose they can be tightened by placing a small stick between the returns, and twisting it round, lastly tying down the end of the stick.

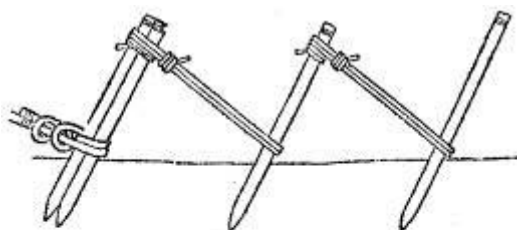

Fig. 200



Fig 201

It is difficult to get a Three-two-one Holdfast to hold on very wet or very friable soil; in any case it should be constantly watched for any signs of giving way when in use.

#### 3. DEADMAN HOLDFAST.

A more secure Holdfast may be made by burying a log in a trench cut at right angles to the line of strain, and passing a rope or preferably a chain round its middle, the rope to come

to the surface through a sloping channel cut for it. If the log is to stay there long it should be tarred.

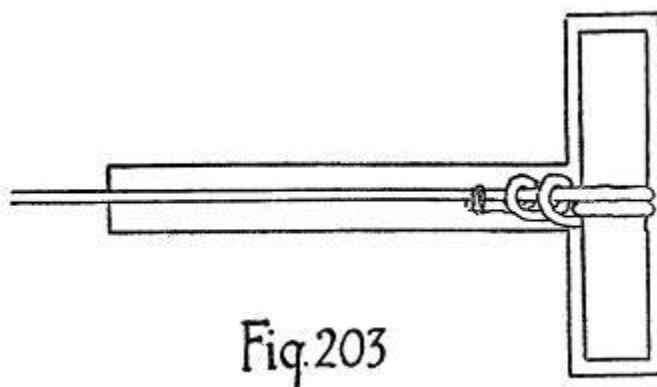
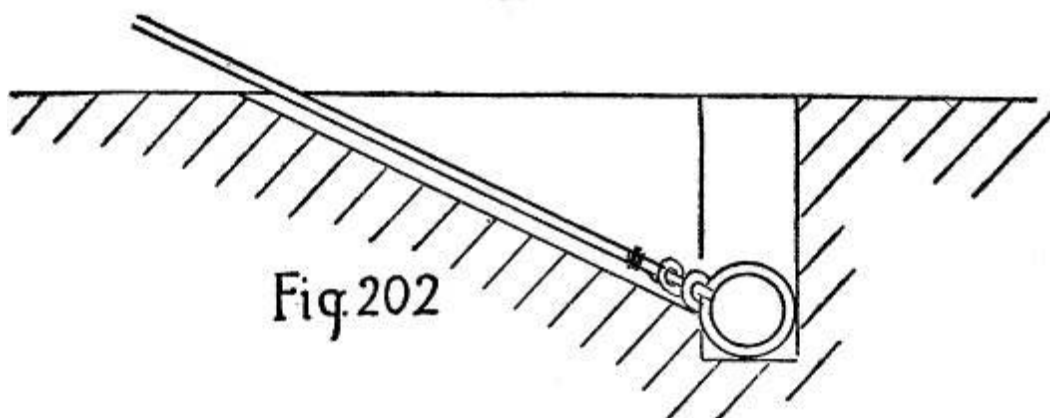

4. It is very important that all Holdfasts which are required to take a heavy strain should be placed well away, so that the strain approximates to a horizontal one, otherwise they are liable to give way. In calculating the distance allowance should be made for a tackle fully overhauled, if one is to be used.

5. In driving a picket with a maul or sledge hammer care must be taken not to split or break it. At the moment when the head of the maul hits the top of the picket the hands should be dropped so that the handle of the maul is at right angles to the picket, otherwise it will be driven crookedly, or may break. It is best to strike gently if unaccustomed to swinging a maul: if a bad shot is made and the handle of the maul hits the top of the picket the handle will very probably snap.

6. It is sometimes difficult to draw pickets which have been driven in wet or sticky soil when they are no longer required. If a spar is used as a lever, and attached to the picket by a lashing – Clove Hitch round picket, Lever Hitch round spar – the picket will generally give way.