

PIONEERING PROJECTS

by

JOHN THURMAN

Camp Chief, Gilwell Park

ILLUSTRATED BY KENNETH BROOKES



Publication Approved

by

THE BOY SCOUTS ASSOCIATION

C. ARTHUR PEARSON LTD.

TOWER HOUSE SOUTHAMPTON STREET

STRAND, LONDON, W.G.2

First Edition 1950
Second Edition 1953
Reprinted 1958
Third Edition 1961

Made and Printed in Great Britain by Butler & Tanner Ltd., Frame and London

Downloaded from:
“The Dump” at Scoutscan.com
<http://www.thedump.scoutscan.com/>

Thanks to Dennis Trimble for providing this booklet.



Editor's Note:

The reader is reminded that these texts have been written a long time ago. Consequently, they may use some terms or express sentiments which were current at the time, regardless of what we may think of them at the beginning of the 21st century. For reasons of historical accuracy they have been preserved in their original form.

If you find them offensive, we ask you to please delete this file from your system.

This and other traditional Scouting texts may be downloaded from The Dump.

PREFACE

IT is encouraging to any author to discover that a book he has written has been in sufficient demand to make further editions necessary. With this particular book I am unusually pleased because I know that not only has the book had a good reception both inside and outside the Scout Movement, but there is considerable evidence that the book is being used as I hoped it would be used.

Additionally, the warning I made in the last chapter of the First Edition might more properly have been included in the first chapter, and I am therefore repeating it here for good measure if perhaps in slightly different wording.

There is only one activity in my experience where it pays to start at the top, and that is swimming. It is true that Pioneering has often been directly if unexpectedly linked with swimming, but if any Patrol, Troop, or Scouter, tries to start pioneering before establishing a sound background of basic Scout training in regard to knotting and lashing, then pioneering will become unpopular and will go down in the history of the Patrol or Troop as a failure. Equally, if one takes this book and tries to build Items 27, 28 and 29 before having a crack at the earlier efforts the chances of failure are immeasurably greater. It is better to do a simple thing well and to progress to something more complicated rather than to try to start with one of my higher flights of lunacy and come down to earth in more ways than one! The order in which I prepared the book was deliberate and experience has shown that in the main it is right.

I want to suggest that we encourage Scouts to make models, working models if possible, of the projects suggested in this book. A great deal can be learned from building a model, especially if it is built to scale and we can find out the difficulties and where special attention and practice are needed. Model-making in itself is fun and a most excellent handcraft and surely pioneering models are more Scout-like than fretwork mottoes and decorated egg-cosies? May I particularly commend to those who deal with handicapped Scouts the value of bringing pioneering within their grasp? For many years I was associated with boys in an Orthopaedic Hospital and I know how they would have revelled in a book of this sort, particularly if they had been offered the chance to make working models of the projects.

Finally, I hope Districts will more and more accept the responsibility for making pioneering equipment available to be borrowed or hired by any Troop. The more expensive things become the more it is necessary to work on a communal basis, and the Scout community is the Scout District. I know the problems; somewhere to store the gear and someone to look after it, but these are problems which a live District can overcome if real determination is there to give Scouts pioneering practice, and I am satisfied that it comes high in the list of things Scouts want to do. Determination remains the enduring answer to most problems.

JOHN THURMAN,
CAMP CHIEF,
GILWELL PARK.

CONTENTS

INTRODUCTION

- I. GEAR
- II. HOW TO BUILD ANYTHING – OR – STAND BACK, SCOUTER !
- III. QUARTERMASTERS AND ALL SUCH
- IV. KNOTSANDLASHINGS
- V. HOLDFASTS, ANCHORAGES, AND TAKING THE STRAIN
- VI. PROJECT No. 1 : COMMANDO BRIDGE
- VII. PROJECT No. 2 : LIFT AND ROPE
- VIII. PROJECT No. 3 : SIMPLE RUNWAY
- IX. PROJECT No. 4 : THE SCOUT TRANSPORTER
- X. PROJECT No. 5 : THE HIGH HOIST
- XI. PROJECT No. 6 : AERIAL RUNWAY
- XII. PROJECT No. 7 : SWINGING DERRICK ON A TREE
- XIII. PROJECT No. 8 : SWINGING DERRICK
- XIV. PROJECT No. 9 : THE MONKEY BRIDGE
- XV. PROJECT No. 10 : THE BUSHMAN’S BRIDGE
- XVI. PROJECT No. 11 : THE LOFTED BRIDGE
- XVII. PROJECT No. 12 : LADDER BRIDGE TO TREE
- XVIII. PROJECT No. 13 : THE LADDER BRIDGE
- XIX. PROJECT No. 14 : SUSPENSION BRIDGE
- XX. PROJECT No. 15 : LIGHT POLE BRIDGE
- XXI. PROJECT No. 16 : THE COUNTERWEIGHT BRIDGE
- XXII. PROJECT No. 17 : THE DRAWBRIDGE
- XXIII. PROJECT No. 18 : THE SWINGING DRAWBRIDGE
- XXIV. PROJECT No. 19 : THE SINGLE LOCK BRIDGE
- XXV. PROJECT No. 20 : THE SWING BRIDGE
- XXVI. PROJECT No. 21 : THE DOUBLE SWING OR THE ROUND BRIDGE
- XXVII. PROJECT No. 22 : SAUSAGE RAFT AND CATA MARAN
- XXVIII. PROJECT No. 23 : THE TARPAULIN RAFT
- XXIX. PROJECT No. 24 : THE PADDLE STEAMER RAFT
- XXX. PROJECT No. 25 : THE GANTRY
- XXXI. PROJECT No. 26 : THE SIGNAL TOWER
- XXXII. PROJECT No. 27 : THE BEACON TOWER
- XXXIII. PROJECT No. 28 : TREE-TOP HOUSE
- XXXIV. PROJECT No. 29 : A CATAPULT
- XXXV. GOOD LUCK!

Introduction

ABOUT THIS BOOK AND HOW TO USE IT

THIS is not a book to read, though I hope it will be read, but I mean it is not a book to sit down and read through from cover to cover. Having written it, I should find reading straight through it a very bewildering process. Rather, do I suggest, it is a book to use. A book, I hope, that will be useful in itself and beyond that will set Scouters using their own imagination to proceed very much further along the various roads that this book does no more than set out upon.

Now a word about the illustrations. Quite deliberately these drawings by Kenneth Brookes are artist's impressions of pioneering projects and are not, and are not intended to be, engineering drawings. They definitely and with malice aforethought do not show each individual knot and lashing. They are meant to be indicative of what you should aim at. I can tell you this, though, that every one of the projects in the book with two exceptions (and they are exceptions only because time has intervened) have been tried out in practice by Scouts, most of them many times, and with a little guidance Scouts have been able to produce a finished article that looks like the artist's impression, but has the additional advantage of working.

It will be a poor day in Scouting when any Scouter or Scout can pick up a book and all he has to do to achieve success in some subject or activity is to copy exactly what he finds in a book, because Scouting is not like that. *Scouting for Boys* itself tells you what to do, but very rarely how to do it. In this book we are going to try to suggest many things to do and to give a few hints, no more, about how to do them. I know there is a fairly constant call from a minority of Scouts, and I am afraid Scouters too, who want to be spoon fed down to the very last dregs of the cup. They want everything so cut and dried that they will know six months in advance that on June 3rd at 7.30 they will be tying a bowline! Dull dogs, I am afraid, who have found their way into Scouting by mistake and would perhaps be happier and of more service to humanity in something less imaginative and rather more definite than Scouting or Scout activities were ever intended to be or, I hope, will ever become.

Nonetheless, it is right to seek help in regard to method. I remember very well a few years ago hearing from the lips of a very senior Army Officer these words: "Never mind about the immediate results; if the method is right ultimately the results will be right too, but if the method is wrong, however good the results may appear, sooner or later disaster is inevitable." So let us concentrate on method, because what I have just quoted to you is so completely true. There will be much to say in this book about method in general and in detail, but I do want to say at the start that the most important method in Scout pioneering lies in letting the boy be the pioneer.

Any Scouter who takes up this book and looks through it may find a small voice saying inside him, "I'd love to have a shot at that." Rather a devilish small voice that, because that is the voice that will lead you into the habits of bad Scoutmasters, of whom in truth we have always had as many as we can comfortably do with. So try to listen for the voice that says, "I'd like to see my Troop making that," or, better still, "I wonder if the Owls, or the Wolves or the Badgers could make that?"

Don't believe from this that I think Scouters should know nothing about pioneering, but the difference between knowing and doing is at once considerable and important. You know quite well that through Training Courses, Scouters' Meetings, and the like, it is very necessary that you, as a Scouter, should become proficient in pioneering as in much else, but it is

Scouting *for* boys, never Scouting for men, and I hope the all-too-frequent spectacle of Scouts admiring or being bored with the efforts of their Scouters will become past history, and that rather we shall see the wise Scouter wandering from Patrol to Patrol offering a bit of advice and a lot of encouragement. Watching every project being built and casting a shrewd eye on the parts that might be dangerous if they were not attended to, intervening with a word often, with an action sometimes, but only when disaster looks imminent. Allowing his Scouts to be the pioneers, that is, starting from the beginning and learning through their own efforts how to overcome the many problems and difficulties that pioneering will present.

One of the most often-quoted passages from *Scouting for Boys* is to this effect – that the frontiersmen, trappers, hunters, pioneers, explorers and missionaries, bushmen, drovers, etc., are men who are ready to face up to any dangers, to help one another, are strong and plucky, observant, and will give up everything, their personal comforts and desires, in order to get their work done: – it seems to me that a pioneer to be worth his salt scorns the way of safety and sets about whatever problems he may have to tackle in a spirit of gay adventure; and in a world that seems to place somewhat inflated importance upon security and safety and dullness, perhaps it is left to Scouting, and in Scouting to pioneering, to keep alive the adventurous spirit that in the words of the old prayer “Makes men scorn the way of safety so that Thy will be done.”

Nothing worth while was ever achieved except that it was set about adventurously, and whilst it may seem a long way from the small boy and his rope and spar and his 2-foot deep stream to the pioneers and explorers, if we can only set alight in the hearts of our Scouts a real desire to adventure, then this country will continue to bring forth men who are prepared to venture out into every field of human endeavour and to achieve much in fact and in spirit to the ultimate benefit of all.

This is one reason why in this book I have suggested you do rather more than remain faithful to the eternal Monkey Bridge and the everlasting Aerial Runway, although both these worthy projects have their places within these pages. Constantly to repeat anything is in no sense an adventure and by no stretch of the imagination can it be considered as pioneering.

Lastly, when you have tried to do something as suggested in this book and the result has been fairly lamentable, don't blame the book, because everything and anything in here can be done, has been done, by Scouts. Don't blame the Scouts. May I humbly suggest you blame yourself? Because you have probably failed in two respects. Firstly, that you have not instilled into your Scouts the wish to succeed and achieve; and secondly, you have not equipped them with the very necessary training that Tenderfoot and Second-Class and First-Class Tests provide. When I was at school we had a somewhat strange old science master whose bug was “back work”. Never a period passed that he did not ask us if we knew our back work, and though we laughed at him, ultimately he got his way. We did know our back work and, strange to say, at least one of his pupils still does! And in pioneering it is those simple knots and lashings that are the basis and the only basis upon which it is possible to build anything. Until we know them and can do them, not merely within the warm comfortable confines of our Troop Room, but out in the open in any weather, in any uncomfortable position, above water and below it, perched precariously upon the top of a whipping spar, or with the poles we would lash together partly concealed by some overhanging branch (squirrel or caterpillar draped). Until, in fact, we can pioneer with the simple basic tools of our job, it is quite hopeless to go any further, and I think I can say to you without any fear of contradiction that the success or otherwise of pioneering in your Troop will be in exact measure to the quality of the training you give in Tenderfoot, Second, and First Class, and to the degree of imagination with which you present these simple tests to your Scouts.

Chapter I

GEAR

I SUPPOSE three of the most frequent questions I am asked about pioneering are “What do we need?” “Where do we get it?” “How much does it cost?”

I can perhaps help most in regard to the first one. I find Scouters very liable to say, when discussing pioneering, “We must buy some poles, some ropes, some blocks,” which is true but doesn’t go far enough. They are rather apt to be like the newly married housewife who knows that she needs, for example, some salt, some potatoes, and some flour, and orders a hundredweight of salt, a pound of potatoes and an ounce of flour, which is liable to make her culinary efforts less effective than she would wish. Our Scouter will perhaps order a vast quantity of poles, some pieces of rope and forget all about the blocks. Well, the Scouter is rather like the housewife in that he needs a recipe to work from before he can cook up any sort of project and he needs a little advice as to what to buy and where to buy it.

Before I started to write this book I had really given a great deal of thought as to how I could present the question of gear to you in a way that would be easily understood and genuinely helpful. Eventually I came to the conclusion that I would use the idea of Meccano, not because I wish to advertise so well established an item but because I want something that will be familiar to most of you. I remember as a very small boy being presented with a set No. 00 which, truth to tell, contained extremely little and enabled me to join about three strips of metal together with nuts and bolts, and to add a wheel at each end and not, really, very much more. But included in the set was a book, and on the front appeared a picture of an enormous crane that would delight the heart of any boy or man. Careful reading of the book showed that No. 00 would not build this, neither would No. 2, nor No. 4, but eventually if one could collect up to No. 6, you could build a crane, you could make it work, you could light it up and you could probably have a disastrous effect upon the comfort of the home by filling one room at least with a remarkable collection of strips of steel and wheels. But how many of us got as far as the No. 6 set? I believe I did once get up to No. 4, only to discover that too many pieces and parts had slid under the wainscoting and I was still well short of the target. Well, I am going to start you off with No. 00. Just with a rope, and gradually I am going to suggest additional pieces of equipment for you to buy or get hold of from somewhere, and with each stage try to show you what I think could be done with the amount of gear you have up to date. Maybe, like the boy with Meccano, you will never get to set No. 6, but no matter. It is always something to have an aim, and even if we don’t achieve it, there is good fun in the trying. At least we ought to get somewhere and we ought to avoid ending up with a complicated collection of odds and ends that have been brought together quite haphazardly and without any sort of thought or plan.

So we are going to start with a simple rope, and on to it we are going to build, and how far you get is a matter for you, and, I hope, particularly a matter for the enthusiasm of your Patrol Leaders.

Now for a few of the rather more technical details.

Ropes

Wherever I have mentioned the size of a rope it is to the circumference of the rope I refer and not the diameter. It is important we should get this clear because different countries and different ropemakers vary a bit as to the way in which they classify their rope. Some use the circumference measuring system, some the diameter, but let us be clear, *we are going to use the circumference*. Never mind whether you like it, as long as you are clear about it.

Now obviously, the rope sizes I am suggesting are not the only possible ones, but by and large remember that it does not necessarily add to the strength of anything to use a heavier rope than the one suggested. It must be remembered, too, that a thicker rope, that is, a heavier rope, weighs more in itself than a thinner or lighter rope. It is a terribly obvious thing to write, but I have seen pioneering projects, bridges, etc., which were completely useless because the ropes used were so terribly heavy that it was as much as the spars could do to hold up the ropes, let alone the Scouts who wanted to add their weight to the bridge.

Then I suppose I must say a word about safe working strains. I don't think we are concerned with breaking strains, at least I hope we are not. It is quite easy to arrive at a formula for safe working and here it is: For hemp rope double the square of the circumference in inches to give a stress in hundredweight; thus, a 3-inch rope would have a working stress of 2×3^2 cwt., or 18 cwt. Most Commissioners are well covered by a 3-inch or even 2-inch rope!

Material from which the rope is made. Well, I suppose it is largely a matter of getting what we can, but do be a little careful in buying or accepting a second-hand rope. It may be all right, but try to find out what it was used for. It may have been over-strained, it may have been very wet, in which case it will probably look all right, but open it up and have a look, because rope rots from the inside outwards, and very rarely from the outside inwards.

Lashings

Now, quite deliberately, I have suggested 10 to 15 foot lashings because long experience has shown us that this is the most useful length. It would be nice to have a lashing cut to suit every job we do, but it would be very wasteful, and we should end up with an immense collection of odd lengths we might never need to use again. When you want to use less than 10-foot it is easy to tuck in the ends you have no use for; when more, join two together.

Well, 10-foot to 15-foot is the general aim and a few rather longer. Ultimately, I hope, a fair assortment of each. If you are lucky enough to be able to get them for yourself, spruce, larch, ash will all be useful. Avoid the brittle woods like crack willow, poplar and, whatever your spars, it is worth the trouble to de-bark them. They last very much longer with the bark off than they will with it on. Don't take my word for this but cut two short lengths, debark one and not the other and leave them out in the open for a year and then see which is the most use to you.

Blocks

Although they need rather more looking after, I am afraid I have got a great preference for wooden ones. In some ways the metal ones are more efficient and you may, in fact, have to get them, but if you can get those lovely wooden blocks with boxwood rollers, then I hope you will.

Well, so much by way of generality about the gear. We shall go into more detail as the book proceeds.

Now, back to my second question – or rather your second question, “Where do we get it?” Frankly, I don't know. I expect you will have to buy a certain amount, and I do suggest if you are going to spend money that you go to a reputable firm, because your chances of being satisfied are so much greater, but I hope you won't have to buy all of it.

This is very much a personal matter for the Scoutmaster; this is one of his jobs, to find the facilities to enable his Scouts to pioneer and, somehow, you know, the really good Scoutmaster does get the gear. He gets some of it himself, gets his Scouts to work for some of it. He may know of an estate where they want some trees cleared and are willing to allow the

Scouts to carry away some of the poles as a “Thank you” for work done. There is a great deal of stuff about, and the wide awake Scoutmaster will see it. You cannot assemble pioneering gear from an armchair. Don’t despise anything you are offered. It may look completely useless, but before you say “No” think. That old farm cart axle – it’s been lying about for years. Isn’t there anything we could do with it? That old tarpaulin that the Civil Defence left behind when they walked out of our Headquarters may come in for something. The Scoutmaster who is going to give his boys pioneering must keep a fair accumulation of what the unknowing would call junk, but he knows there is a use for it if only he can think of it.

But there is another source of supply. There is never a Troop who is not embarrassed sooner or later by the offer of something they do not want. It may be a silver cup for doing some fairly futile thing; it may be a silver-mounted walking stick for the Scoutmaster; it may be an ornamental weathercock for the Troop Headquarters. Well you may, of course, want all or any of these things and be glad to have them, but I know when I had a Troop and some well-wisher – and remember they are well-wishers – offered us something which we did not particularly want, I asked them if perhaps they would not mind giving us a 50-yard 2-inch rope; or a new set of blocks, and most people, you know, would rather give us something we want, rather than something they think we want. It all comes back to the Scoutmaster knowing what he does want.

Whenever we had parents or supporters visiting the Troop Headquarters there were always lists of things on the wall showing what we wanted, and it was amazing what was offered and how well equipped we became in quite a short time.

I remember we once had an “At Home” day in the Headquarters and over the tea buffet appeared this notice “Sorry there are no saucers – we have no saucers!” Within a week we could have set up in business as saucer sellers. People don’t mind being asked and they do want to know what it is we need, and sometimes that quite unlikely looking gentleman from the city may well have a brother or a brother-in-law who is a Ship’s Chandler down in Wapping. If you don’t make your needs known, then it is very difficult for people to help you. What this amounts to is, do take an active line in getting gear. Don’t just sit down and say times are difficult. Of course they are – they always were! Don’t put off your Scouts with tales of short supply and export drives. Take the line that if there is only one piece of rope available for Scout purposes – my Troop is going to get it. And, finally, when you have got it look after it – but that is another chapter.

Chapter II

HOW TO BUILD ANYTHING – OR – STAND BACK, SCOUTER!

I AM almost tempted to leave the chapter heading in very large type and say nothing else, because if only the Scouters would stand back, pioneering for Scouts would be so much better and so much more fun.

I wonder if I can put it this way – may I ask you, as a Scoutmaster, how you regard yourself? Are you a Scoutmaster who is concerned to train and develop the characters of your Scouts through the application of “Scouting for Boys”, or are you just an overgrown Boy Scout? Do the activities of Scouting, including pioneering, appeal to you so much that you just can’t keep away from them? I expect your immediate answer is, “Of course, I am a Scoutmaster,” but I

am going to suggest to you that you examine your motives not just to-day but fairly frequently, because so many of our Scouters to-day have stopped training Scouts and are pursuing the very proper pursuits of Scouting for Boys on their own account.

I have said already, and I repeat here, that you cannot know too much, but the trouble is – and the difficulty is – that you and I can *do* too much.

I hope that pioneering in your Troop will, in the main, be a Patrol activity. Some of the things I am going to describe in this book certainly require more than one Patrol, but the jobs can still be broken down so that each Patrol has its own particular task to fulfil with you, as the presiding and guiding genius of the whole affair, but I hope a somewhat inactive genius. I might almost put it this way. If, in pioneering, anyone is to get cold, it ought to be the Scoutmaster.

There are certain questions that anyone engaged in pioneering must answer before he can proceed very far. After a bit of practice, of course, you don't pose the questions deliberately, you develop almost an instinct for knowing the right answers, but I think it may help to clear the air if we do put the questions down in cold print and discuss them together.

Question One: What have we to do? That is, what are we going to try to achieve?

Question Two: What do we need to achieve it? That is, in fact, a list of equipment. You will find at the head of each of the projects a list of what you will require, but this is an imperfect world and even if all the lists are right, which I hope they are, it will be a strange Troop that finds it has the gear complete or exactly as described. One of the great joys of Scouting is improvisation, so that what this question really means is “What do we need?” for the first part, and “What have we got?” for the second part, which brings us back to the first part “What do we still need?” and there you may have to improvise, you may have to borrow, you may have to alter, or join up because you are short of a block or are minus the right length of rope. A little determination, a lot of imagination, and a great deal of ingenuity will overcome most shortages.

Question Three: Where are we going to do it? Well, presumably we can answer that very easily, but what I really want you to do is to survey the site. Really have a look at the tree, or stream or whatever it is before you start fiddling about with the equipment. Enthusiasm is a grand thing if it is used in the right place and at the right time, but the bull-at-the-gate method of pioneering merely courts disaster and eventually disillusionment, because you will not achieve anything, you will work extraordinarily hard, and apart from a certain amount of testing of tempers, the value you and your Scouts will obtain will be quite negligible.

The fourth question I should like to put to you is “*How long have we got?*” I would go on to suggest that it is always a good thing to work against time – or nearly always a good thing. Don't set yourself an impossible time schedule so that you have to skimp lashings and leave out important pickets and so on, but do give your Scouts a fair idea of how long they have got, so that the Patrol Leaders can do their own bit of planning and assess, as the job progresses, just how they are getting on and how much further there is to go.

And, finally, two questions that I am going to merge into one, “*Who is going to do what, and in what order?*” “Who is going to do what” is a matter for the Patrol Leader. His job is to allot the various tasks to his Scouts so that they all have something interesting to do and they are all kept busy the whole time. And the other part of our question, “In what order?”, well, that I shall have to try to bring out in the case of each project, but it means that there is an order; sometimes it is very obvious, sometimes it is not so obvious. At what stage, for example, do we get the gear across to the other side of the stream? It may be amusing, but not good pioneering, constantly to be lugging a spar backwards and forwards because both parties need it. It is not good pioneering to fix a rope on an aerial runway with a mass of

accurate and beautifully tied knots, only to find you have forgotten to put the pulley block on the rope before you fixed it up. Most of us have done this kind of thing and maybe many more people will do them, but by and large it is a waste of time and shows we do not think the job out before we start.

One of the most important things in Scouting, and one of the least used, is the Patrol-in-Council. In pioneering it may well operate in this kind of way. You want one of the Patrols to build one of the things in this book. You give the Patrol Leader the book, tell him what you want made, and say "Get on with it." The Patrol Leader of the Monkey Patrol will set his hordes on to the pioneering equipment; they charge at it, will pull out a spar, a block, a piece of rope and these they will proceed to tangle. They will drive pickets into the bank of the stream, they will let the sisal slip into the water and float away out of reach, they will have a grand time, but they won't build a bridge, nor indeed anything else, and they will never have the satisfaction that can come only from completing a job well and sensibly; but the good Patrol will leave the gear alone. Their Leader will say, "Patrol-in-Council," the Scouts will gather round and look at the drawing; they will go and survey the site and then with hands securely behind backs they will go and *look* at the gear.

They won't touch a thing until everybody knows just what he is to do, in other words, until they have a clear idea of the *modus operandi* of the whole business.

I have left till last the questions that have to be answered very much later in the proceedings, but now I put it to you. "*Have we cleared up? Have we accounted for all our gear? Have we left the site so that there is no trace of our activities?*"

A pioneering site is in no way different from a camp site, and on that, as you know, B.P. said we leave nothing but our thanks. But, of course, it is impossible to check gear unless we checked it before we started. It is impossible to leave the site as we found it unless we surveyed it before we started. The real test of the good Patrol is how they finish. Good finishing in pioneering, as in running, is the thing that ultimately counts. I know it is tremendous fun starting anything and I know that perhaps it is not quite such good fun clearing it up. We are getting a bit tired, we have had enough. Dinner begins to call. It has taken rather longer than we thought. We have got a good trek back to camp or our headquarters. That is the testing time! That is when the Scoutmaster may have to intervene and encourage and, indeed, lend a hand. No bad thing for the Scoutmaster to lend a hand with the dull jobs and remain quiet during the more interesting ones.

One last thing now for this chapter and then we will really move on to the individual projects. Don't take anything for granted. By that I mean, do test the soil you are going to drive your pickets in. We have talked about that already. Do test the tree you are going to fix the main rope of your bridge to. Don't assume that that substantial-looking rock on the other side of the stream is secure. In short, BE PREPARED!

We might here say a word about trees. By and large, of course, a live tree is more secure than a dead one. That is generally true, though not absolutely true. A dead oak is very often one of the most secure trees you can find, but oak trees in the main don't grow near streams where we shall probably be bridging. The most common of our water-side trees is the alder, which is a pretty reliable one, although if there are too many roots showing it may mean that the bank has been washed away and the tree is not firm. Another waterside tree is, of course, the willow, though that may be a bit dangerous, especially the crack willow, which will almost certainly live up to its name if you trust him. It is better to make a bridge a bit longer and go inland a few yards to find a more substantial tree. And that reminds me of another thing. I am all for the adventure of pioneering, but it needs to be a reasonable adventure, that is, an adventure that an average person can hope to take part in and enjoy.

Some of the pioneering feats of Scouts that I have been asked to test were suitable, as far as I could see, only for a trained acrobat. I have grim memories of a flimsy monkey bridge perched on a high embankment so that the roadway was more than 30 feet above less than 1 foot of water. An uninviting situation. An aerial runway which was a joy if only there had been a way of getting into the bosun's chair! The beautiful suspension bridge where the first rung of the footway was 7 feet from the bank. All very entertaining no doubt, but hardly pioneering. I think the test is: "Can a middle-aged man of reasonable girth and in full control of most of his faculties get on your bridge and cross it with reasonable expedition, arriving safely at the other side," and that, I hope, includes most Commissioners who will like to sample your Scouts' efforts, but who may find it beyond the scope or intention of their duties to risk life and limb on some carelessly built, though enthusiastic and well-meant effort.

Chapter III

QUARtermasters AND ALL SUCH

The unpopular people in national life. For some reason he is often regarded as a **THE** Quartermaster by tradition and by practice is, I suppose, one of the most **cha** rogue and nearly always regarded as incompetent, and generally is the sort of chap that when we meet him we pass hurriedly on. Well, no doubt there are Quartermasters who qualify for our dislike, but nonetheless we need a Quartermaster in relation to our Troop – in fact, we probably need more than one.

I think we sometimes get a bit muddled up about what brotherhood means. Some Troops seem to translate brotherhood into terms of perpetual muddle. Nobody is in charge of anything because we are all in charge of everything, and along that road lies chaos and a great deal of heart-burning and, not least important, waste.

Suppose we begin from the point of thrift? I know if I ask the average Scout what he means by thrift he would answer in terms of money and leave it at that. Whereas the truth is that thrift in regard to money is of so much less importance than thrift in regard to property, especially in an age where our is difficult to acquire and money, at the time of writing and speaking in no sense personally, seems to be comparatively easy to get. It is just bad Scouting to obtain, to purchase, to get from whatever source equipment, most of which is expensive, some of which is rare, some of which is unique and irreplaceable, and then from a distorted idea of jollity and good fellowship, to leave it all lying about to rot, disintegrate, and disappear. Additionally, the job of Quartermaster, that is, somebody who looks after the gear, is a first-rate job for a young Assistant Scoutmaster or Troop Leader, supported by as many senior chaps as are willing to lend a hand. So let us be agreed that it is necessary for somebody to be in charge of equipment, and let me say quite firmly that the person to be in charge is not the Scoutmaster. I am sure the Scoutmaster would do it very well; I am sure he would like to do it, but I cannot say too often that his job is running his Scout Troop and that does not include absorbing all the minor jobs that a Troop's needs involve.

There are three kinds of Quartermaster, though, in Scouting. The first does the job thoroughly, sensibly, and efficiently. We will come back to him in a moment because he is the chap we want.

The second doesn't do the job at all, nothing is ever put away, nothing is ever accounted for, he is quite useless and ought to be got rid of; and the third – he is really the dangerous one because we may not suspect him until it is too late – he is the one who does

the job so well, is such a thorough fellow, that in our Troop we cannot do any pioneering at all because the Quartermaster tells us: "that it is raining, therefore, we must not take out his new rope." "That the last time we built a monkey bridge somebody broke two pegs, and through hitting a picket there is a dent in the smooth surface of his mallet." He suffers from the Park Keeper's complex, that is, of feeling so great a pride in his job and all that goes with it that it tears at his heart-strings if anybody wants to use any of his gear. His idea of being a Quartermaster is having everything clean, in bright new condition, carefully labelled and put away, and he is horrified at the idea of anyone taking anything out of his store, and is full of excuses for why something should not be used, and will probably produce remarkable programmes to avoid using his treasured possessions, because that is what to him they become. Yes, he is a dangerous young man, this one, and that is why it is so necessary when anyone is asked to be Quartermaster that they are told very clearly what the job is and what is expected of them and what is *not* expected of them.

Well, let us go back to our first chap, the chap who is going to be a good Quartermaster. He is going to enjoy doing it, he is going to take a pride in the job, but he is going to allow us to do our pioneering. What sort of a chap do we want? Well, first and foremost, a nice chap, a chap who will learn, if he doesn't know already, how to sympathise with a Scout who has had a bit of bad luck and who has broken a couple of pegs, and how to be wrathful to the P.L. who through sheer carelessness has lost three lashings. The distinction is important. If we are going to do pioneering there will be a natural wastage of equipment, things will get broken, they will get worn out, they will have to be replaced, and it is right and proper that we should realise this and provide for it. What we must not countenance because it is bad character training is the wilful destruction of gear, or equipment which is lost through sheer carelessness, and the good Quartermaster will learn to distinguish one from the other.

Then in our Quartermaster, "Ideal" pattern, we want orderliness, but that should mean no more than he knows what he is responsible for. He knows what is out of his store and who has it, and when it is due to be returned, but we don't want a chap who produces such an elaborate system that before Scout can get hold of a 10-foot lashing he has to fill in two forms in triplicate, enter his name in a book, transfer a card from one part of an index to another, make three promises of increasing severity, and pay a deposit of ten shillings. All this may sound an exaggeration to you and in total perhaps it is, but each one of those things has been known to be done. Is it any wonder that the P.L. thinks life is too short for this pioneering business? He would love to build a bridge with his Patrol, but really he can't face the wrath of the Quartermaster, nor spend the time necessary to draw the equipment from the store. We do need an orderly system of recording what is what, but it does need to be simple and, above all, one that can be implemented quickly.

Now our ideal Quartermaster is not going to rest content until he has adequate storage for his gear, and he is probably going to worry and fuss until something is provided, and here again let us make sure that what is provided is reasonable and sensible and, not least, is accessible. I remember seeing a most magnificent collection of gear, but short of taking half the building down it was fairly impossible to get anything out of the store, because this store was run by a Quartermaster Mark III, who was indignant and horrified at my suggestion that perhaps some of the gear might be used. He had a sort of collector's mania for keeping it and looking after it. Very impressive to the uninitiated; magnificent, but also very stupid.

No, we want somewhere that is reasonably dry, as far as possible safe from the ravages of rats and mice, and is big enough for gear to be seen and be got at without everything having to be moved and, not least important, we want some place for repairs, because the

Quartermaster needs to be a handyman, to be able to repair a damaged splice, re-haft a broken mallet, oil and adjust a block, and if he does his job well he will always make his repairs before he puts any gear away.

It is really a grand job for a young man and will give him a wonderful grounding in being neat, being orderly, and not least in being tactful.

I expect a lot of you who have read this have said, "Yes, but we have nowhere to keep gear. We meet in a Church Hall and have only a cupboard." Well, I suppose your difficulties may be insurmountable, but I am not sure that they are. I am really sure that the real live, keen Scouters and Patrol Leaders can get what they want if they are sufficiently determined and sensible to go about it. It may take a long time, but unless you aim you will never hit anything and, really you know, the Troop that is still, after twenty-five years' existence, meeting in the Infant School has not shown very much determination; in fact, it has not done any pioneering on its own account.

Chapter IV

KNOTS AND LASHINGS

QUITE obviously there is no room in a book of this nature to deal in detail with every knot and every lashing, and I hope all Scouters have an up-to-date copy of Gilcraft's *Knottling*, which covers the subject very fully, but I am including here something about the knots that will be used a great deal in pioneering and knots, which, for a variety of reasons, seem to give a lot of trouble to Scouts.

Quite recently I watched some Scouts engaged in a lashing competition. Quite half of them – and amongst the half were a goodly sprinkling of First Class and King's Scouts – were tremendously handicapped because they just could not tie a clove hitch. It is not true to say that they did not know how to tie one, only they had not tied one for such a long time that they were all fingers and thumbs, and sometimes it took them two or three false starts before they got the right answer. Now in knotting and pioneering it is so very vital that the Scout learns the right way. There is a proper way of doing everything, and some of the trick methods Scouters are so keen to show off belong more properly among the accomplishments of the conjurer rather than amongst the equipment of a Scouter. We must see that a Scout learns a sound way of tying a knot, one that he will understand, one that he will remember, and one that brooks of no possibility of muddle. That is the snag about trick ways. To the expert – I almost said fanatic – these trick ways are the very breath of life, they can be a great success at any party, but they won't be such a success when it comes to the more-important and less-spectacular job of lashing together two rather cold and heavy spars on a November morning. Then he will find that, shorn of the warmth and comfort and admiring glances of the audience, he is left to face a cold, hard world without a sound, simple method of tying knots which alone would provide the answer to his problems.

The Clove Hitch

Use: for securing a rope to a spar or pole.

The clove hitch completed:

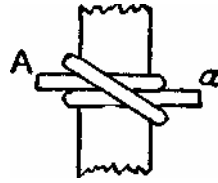

It consists of two similar half hitches, the second one placed behind the first:



and it is made in this way when it can be slipped on to the end of the spar.

When the end of the spar is not available – take a half hitch round the spar, and note whether the running end is on top or below:

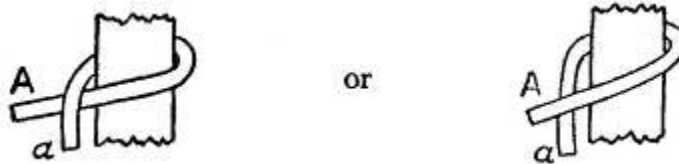

Hold this hitch out of the way with one hand, while another similar hitch is made, quite separately, in the first case below the other; in the second above. Similarly with a horizontal spar, if the running end of the first hitch comes off on the right, the second must be made on the left, and vice versa.

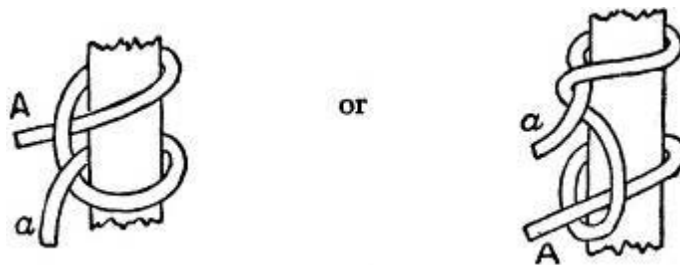

The first and everlasting thing to remember about the clove hitch is that it is composed of two half hitches. What a very obvious thing to say, but there is hardly one Scout in a hundred who learns what it means. If only we can get Scouts to learn that if you make one half hitch and another half hitch and bring them together they make a clove hitch, what a lot of time the Movement would save in the amount of fiddling and fumbling that goes on when a clove hitch is the order of the day. We would be able to start in the sure knowledge that we can make clove hitches and pass quickly on to better and brighter things.

Rolling Hitch

Somewhat similar to a clove hitch, but less likely to slip under a sideways pull. Useful for attaching a rope to another rope which has a strain on it.

Start with a half hitch, as in Fig. 1. Then take a round turn, round standing part and larger rope, as in Fig. 2.



Fig. 1.



Fig. 2.

Then a half hitch on top similar to the first one, as in Fig. 3. To make doubly sure, twist the running end round the fixed rope, in the opposite direction to that in which the hitches have been made, and stop it down.

It is important that the direction of strain is against the double strand. In the illustration the strain is taken downwards. The knot can just as easily be tied to work the other way.



Fig. 3.

There is a difficulty about this hitch and very few books on the subject have ever made it clear. The plain fact is that there are two rolling hitches. They are the same in one respect and quite different in another. I hope the diagrams will make it quite clear to you what I mean. The rolling hitch must be made with a certain knowledge of the direction in which the strain is to be taken. If you make a right-hand hitch for a left-hand pull the hitch is completely useless and, of course, vice versa.

Timber Hitch

Used for securing the end of a rope to a spar or package. The harder the strain the tighter this knot will hold but it never jams.

Pass the rope round the spar, make a half hitch round the standing part and make several twists in the same direction as the half hitch.

Very useful for towing spars if an extra half hitch is added, as in diagram.

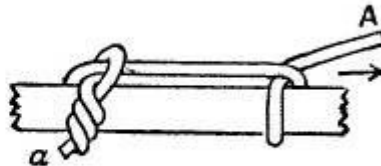
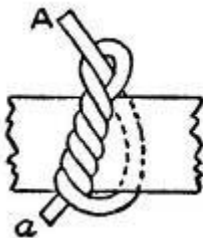

The Scaffold Hitch

Lay the short end of the rope over the plank, leaving enough hanging down to tie to the long rope finally. Wrap the long end loosely twice round the plank as in (a) below. Carry

rope 1 over rope 2 and place it between 2 and 3 (b). Carry rope 2 over ropes 1 and 3 and over the end of the plank. Take up the slack by drawing on the two ends of the rope, and join the short end at a convenient distance above the plank to the longer with a bowline (c). This hitch can also be used for fastening a bundle of sticks or poles together.

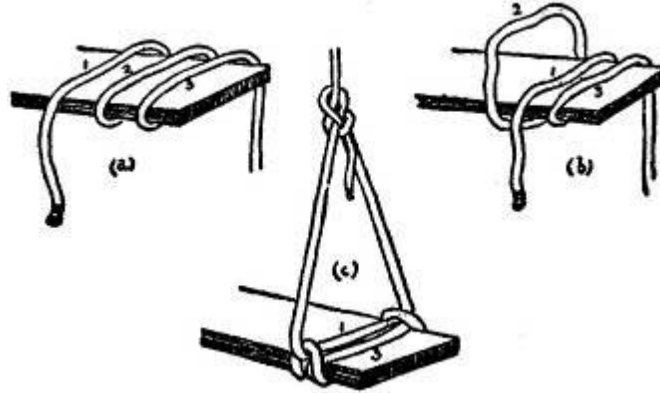

Blackwall Hitch

For fixing a rope to a hook (Fig. 1).



It may be strengthened by taking a turn round the neck of the hook first. The ropes should cross each other behind the hook, standing part on top, as in Fig. 2.



This is called a double blackwall hitch.

If the rope is greasy, make a blackwall, and take a bight of the running part behind the point where it crosses, and bring it over the standing part and on to the hook of the block. This is called a midshipman's hitch.



The Square Lashing

This is the most widely used lashing for securing one spar to another, when they cross each other at right angles, or nearly so. Particularly when the strain on the spars tends to pull them together.

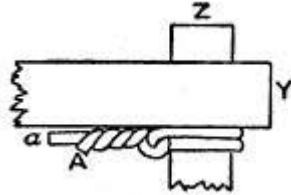

Start with a clove hitch round the bottom or most secure spar (Z) immediately below the spot where the other spar (Y) will cross it. Twist the running end round the standing end, so that the friction against the spars will hold it firm.

Now pass the lashing in front of and over spar Y, behind spar Z above spar Y, down again in front of spar Y on the other side of spar Z, and behind spar Z again below spar Y.

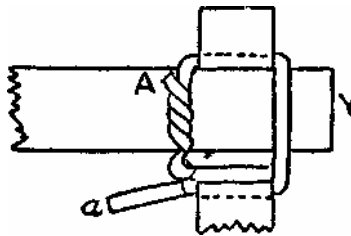

This is one complete turn, and we require three or four like it. Pull each turn as tight as possible. Follow therefore the same procedure again, and, in order that the turns may lie flat, make them either inside the previous turns on spar Y and outside them on spar Z, as shown above, or the reverse, outside on spar Y and inside on spar Z.



Now comes the last stage, called frapping. The lashing is passed round one spar and then completely round between the spars, and over the first returns several times, to draw the whole firmly together.

This needs tight work, and while one Scout pulls hard on the end of the lashing another beats in the turns at each corner with a frapping mallet.



The lashing should be finished off with a clove hitch round the outside of spar Y. And be careful to arrange your clove hitch so that it cannot slip round and loosen the lashing.

Diagonal Lashing

This is used to lash together two spars which from their position tend to spring apart.

Begin with a timber hitch round both spars, drawing them together, then take three or four turns round each fork, then frap, and finish with a clove hitch.



Sheer Lashing

Used for lashing together two parallel spars, or two spars which will be opened slightly out of the parallel to form sheer legs, or for lashing spars end to end.

Start with a clove hitch round one spar and twist the running end round the standing end. Take seven or eight turns round both spars, then a few of frapping turns, and finish with a clove hitch round one spar. If the spars are close fitting a small piece of wood should be placed between them to keep them slightly apart, otherwise difficulty will be experienced in inserting the frapping urns. When sheer legs are opened out the lashing becomes tighter.

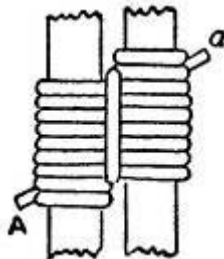

Too few Scouts realise that there are two sheer lashings, which appear the same but are, in fact, quite different. The first is the lashing we use when we want a pair of sheer legs, that is, when we place two spars side by side, lash them together and then open them out. With this lashing we must not put it on too tight, otherwise it is impossible to open the legs out, and if we do open them out we strain the lashing and perhaps create a fatal weakness, and in this form of lashing we make our first clove hitch round one spar only and, by the

grace of the gods of knots, lashings, or whippings, it does not matter which spar we use, so here at least is one thing we cannot go wrong about.

The other form of the lashing, though, is quite different and used for a definite purpose, and here we want to add to the length of a spar to make the side of a tower, a flagpole, or whatever it is, and the lashing must be put on tremendously tightly and the initial clove hitch tied round both spars together.

Figure-of-Eight Lashing

For lashing the tops of three poles together to make a gyn, or tripod.

Lay the spars alongside each other, two outside spars running one way and the centre one the opposite way. Start with a clove hitch round one of the outside spars, twist the running end round the standing end, and give six or eight turns round the spars working under and over alternately like a figure-of-eight. Frap between each spar, and finish with a clove hitch.

I hope you haven't skipped through this chapter saying, "I know all that," because frankly I question if you do, and I doubt whether the average Scout does, anyway. I see him in action so often that I know it is these things he doesn't know, or if he ever knew them has forgotten. They are all small, and apparently minor points, but the strength and success of any pioneering project depends far more on clove hitches and the like than upon anything else. Brilliant and imaginative feats of engineering skill will tumble into a jumbled mess of spars and ropes unless those initial clove hitches to the lashings have been made accurately and put in the right places.

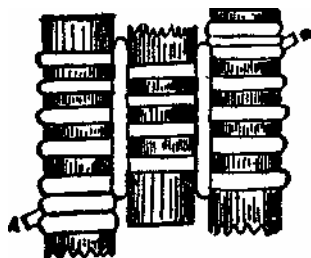

Like most of our Scout activities, pioneering is composed of a lot of "littles," and until we realise just how important these "littles" are, and the effect they have upon whatever we are doing, so long will our success in pioneering or, indeed, in Scouting, be limited.

Lastly there is this to say about knotting and lashing. Building bridges, towers, and rafts is not the place where you learn to make lashings. You learn in the Troop Room and in the out of doors through much more minor pursuits, and when a Patrol or a Scout shows that he really is expert in the art of simple knotting and lashing, then, and only then, should he be turned loose upon pioneering. This is sense in terms of pioneering, but it is also sense in terms of character training, because if we handle our affairs rightly we need an almost endless succession of carrots to hold out in front of the donkeys in our Troop, and pioneering is one of the most attractive of the carrots that we can hold. Sufficient to say that even the driver of the donkey has a taste for carrots, too!

Chapter V

HOLDFASTS, ANCHORAGES, AND TAKING THE STRAIN

WHEN we are pioneering it is quite simple to divide anything we are going to try to achieve into two distinct classes. In Class One we would put all those projects which we could describe as self-contained, projects that in themselves are thoroughly self-reliant, that is, of course, if we build them properly. What I mean is that things like rafts either float or they don't – according to how we build them, and things that are based on trees: well, if we fix them properly they will be all right too. But Class Two is rather a different proposition, because into Class Two I would put all things that depend for their success on their relationship with the ground; bridges, towers, and things of that sort, where so often we have to fix the finished job to the ground in some way or another. Well, this chapter is really about Class Two.

What is there to say about it? Well, in the first place I suppose we ought to consider the things which we are going to have relationships with. Sometimes I am afraid we overlook these. A Scout Troop has relations with its parents, I hope. All of us have relations with other people. The more we know about other people the more we understand them, then the more likely are those relations to be very friendly. Just so with pioneering and the soil. It is very important indeed to know just what lies under the ground, and I do stress *lies under* the ground. By and large top-soil anywhere in this country looks about the same: the kind of places where we shall build our bridges, on banks of streams and so on are pretty well bound to be covered with grass of some kind and to some degree, but top-soil is not really what I am concerned about. It is what is underneath that matters, and without going into geological details (even if I could), the plain fact is that unless you know what is underneath, that is whether it is the firm, holding soil like clay or loose shifting soil like sand, well you are going to be in very grim trouble before you have got very far. In terms of building a bridge I think this means that before you start to build it at all you drive in a trial stake. An ideal sort of thing is a tubular stake, a piece of gas-piping, or water piping, you don't need anything very long, in with your other gear. Drive it in, get it out again (perhaps it is quicker written than it is done), and then you will see what kind of soil the pipe has collected. It is very important indeed to know just what you are going to start building in, because this chapter is about anchorages and holdfasts, and what we decide to use does depend largely on what we are going to use it in. It is no use, for example, sticking a picket into loose sandy soil, putting a huge strain on it and hoping for the best. Hope is a grand thing, I am all for it, but it does not really get us very far unless we ally it with knowledge. So, first, know your soil, test your soil and then, that is where I hope to help you, make sure you are going to use the right sort of anchorage in the right place.

That, then, is part of the problem. Using the right thing at the right time in the right place. But it is one thing to know what to use, it is one thing to know the conditions you are going to use it in, and it is something rather different to know how to make your anchorage so that you can rely upon it. Incidentally, anyone who has done any bridging, I think, will agree with me that you always need with a bridge a sort of sentry, that is a chap who stands by and watches anchorages, hooks, mousings, and all the very important parts that are not very spectacular but are liable under a strain to give way. A very good thing for a Patrol Leader to appoint a very responsible member of the Patrol – perhaps the Second – whose job it is to stand by and watch. The moment he sees anything beginning to give, everybody off the bridge without panic, and refix or renew as necessary.

Suppose now we consider the various types of anchorage. One of the best known, and indeed one of the most ill-used and least understood, is the three-two-one picket. First of all, in regard to pickets generally. They need to be stout, of course, but they need to be unbrittle: a good bit of ash is fine for the purpose: it is no use using a very old piece of wood that is going to crack where it goes into the ground as soon as you get a strain upon it. Pickets ought to be renewed fairly often – about every two years anyway in our pioneering gear. They won't cost much, in fact we will make them ourselves. It is better to have your picket longer than you really need because you are going to bash the point of the picket into the ground so it will need re-sharpening very often, that means it will gradually get shorter just as a pencil does, and at the other end we are going to bash it with a maul, or anyway with something pretty heavy and that is going to shorten it a little, too. Not a bad thing to bind the top of your picket with metal bands. The kind of thing you can do quite easily yourself. Iron heated up and bent round to shape, an old piece of lead, a bit of piping, something that will offer a little resistance to the heavy blows we are going to use with a mallet.

Our pickets, then, a little longer than we need: 4½ to 6 feet, I think, is about the size for most jobs. Anything less than that is stupid. And pickets we shall use only in good firm ground. Gilwell clay is ideal for pickets, till you come to try to take them out and then you wonder if it was so ideal. Incidentally, there is another reason for having pickets a little longer than at first right you think you need them. You've got a good bit above ground and then you have something to work upon when you come to try and loosen it. And a picket left in the ground after the bridge is down is a poor sort of clear up: it means we haven't left our site as we should.

Well, now, angle of picket. We try to avoid being technical because I don't think it really helps to go into a lot of mathematical reasons. We ought to enjoy our Scouting to get it right, and a lot of things in pioneering, as in much else of Scouting, I hope we will accept without the scientific reason as to why we do them. Generally a picket must be in exact line with the rope that it is supporting. If your rope comes to the picket at an angle, well you are obviously increasing the strain and you are asking the picket and the rope to do more work than is necessary.

Suppose we look at a simple example. A pair of sheer legs, coming from a monkey bridge. The rope comes over the crutch of the sheer legs and we place our picket in a direct line with the crutch and the line of the rope coming across from the other side of the river. This, I hope, makes it quite clear what I mean. Now that really is very important. That is where the Patrol Leader ought to come in. He is the chap who decides the line of the bridge, he decides the exact spot where the picket is to go. So often Scouts dash haphazard at a job, full of enthusiasm, bang in pickets with tremendous force, get them in the wrong place and then the bridge ends up with a sort of weeping willow effect, which is quite unsafe and really not very good fun. One of the jobs a Patrol Leader has to fulfil is that of foreman. He must decide where a thing is to be, when it is to be done, and, of course, who is to do it.

Well, now, let us consider our three-two-one picket. Here again is a sketch. I only want to remind you, point out to you two or three significant things about it.

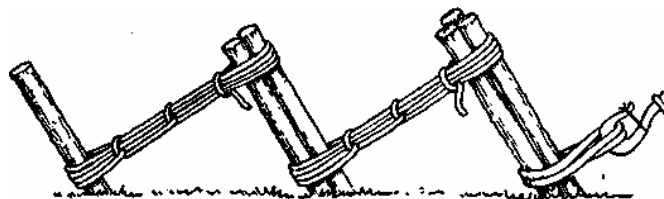

In the first place, the main rope arrives at the first picket, that is the “three” picket so that the rope at the point where it meets the picket forms a right angle, and it meets the pickets at ground level. This is very vital. Any other angle means excessive strain, that is strain more than is necessary, and that is what we want to avoid. Secondly, the support from the three pickets at the front given by the two pickets behind. There again the rope going from the top of our “three” to the base of our “two” forms a right angle, similarly from the top of our “two” to the base of our “one,” again we have a right angle. This means, of course, that we must make quite sure our pickets are properly placed, that they are exactly where we want them and not vaguely right. In other words, we measure out with our lashings before we drive in our second or third line of pickets. The pickets themselves will be seen to be forming an angle of approximately 60 degrees with the ground, but this will vary. It will vary, of course, according to the angle at which the main rope approaches the picket, but by and large by moving the picket about you can always get an angle of 60 degrees, and that is roughly what you want, because it does give the best results.

Well, now, what else is there to say about these particular sorts of picket? I have suggested get the angle right, put them in the right soil, that is good binding soil, not a loose, giving soil; that you have a Scout standing by to watch them the whole time and tighten up perhaps if necessary. What I haven’t said and what I want to add now, is do try and get these pickets looking businesslike and tidy. There is nothing worse in pioneering than a loose end. You will notice in the drawing that all the unused ends of the lashings have been carefully filed away, as it were. It is important this, because it is so easy to get tangles.

In most cases, of course, “three” and “two” would do very well, or “two” and “one”. You don’t always need to go the whole hog, as it were, and put in the whole set of pickets, but it is better to be safe than sorry in pioneering and there is nothing more important than the holdfast you give your structure, so I have a strong preference for using the extra pickets even if I am satisfied we might get by without them. But if you are short, as you may well be when you start pioneering, as long as you test your bridge before you use it, make quite sure by observation that the pickets are holding, that they are good pickets that won’t snap; well then it is not an unreasonable risk to miss out one set, but remember the greater the span of your bridge, the heavier the ropes you are using, the stronger your pickets must be because the greater the strain you are going to place upon them. Well, so much for that sort of thing.

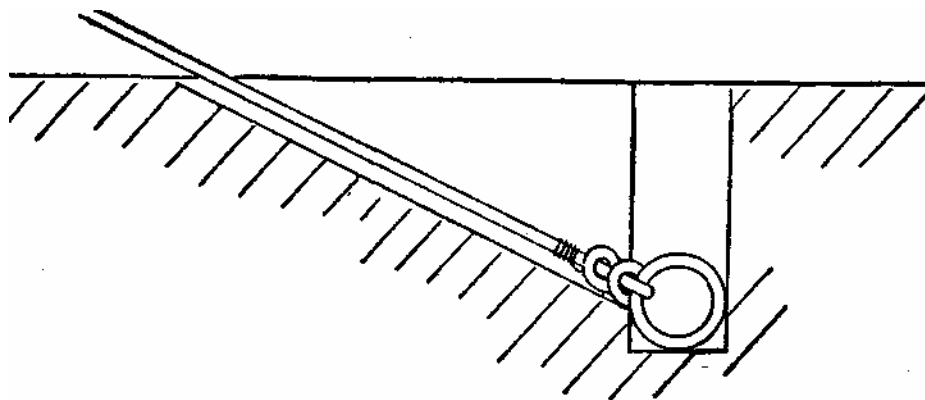

Now supposing we have quite a different sort of situation. Let us imagine we have shifting loose sand or gravel. We put in our pickets, fix our ropes to them, and as soon as you put any strain on them – out come the pickets. Well, there is an answer, but it is a bit laborious. The diagram shows it quite clearly. The Dead Man’s Anchorage. We dig a trench of a depth according to the looseness of the soil, that will determine how deep we have got to go, but believe me it is always deeper than you think, and it is always deeper than you

want to dig, but if you are going to build a bridge in that sort of soil, dig you must. Note the diagram. Nearest to our sheer legs – we'll still use the same examples for clarity – close to our sheer legs our hole is dug sheer, that is, straight in from surface to bottom, and leading out of it we have a trench, a trench that will be at the same angle – this is important – as the rope comes away from the sheer legs. We fasten our rope; timber hitch, round turn, and two half hitches, anyway fasten it with a good knot to a heavy weight – a log, anything you like. Here's an occasion for using a nobbly log and not a nice smooth round one. I remember very well building a bridge with some Scouts. We thought we'd use a Dead Man's Anchorage, and the only thing that was available was a garden roller. It was quite a heavy one. We made fast to it, we buried it in the ground and we proceeded to build our bridge. The first Scout on had a very sorry time because he was literally chased across by the garden roller, which suddenly came out of the hole and rolled towards the sheer legs. A strange sight – it might have been quite disastrous. The mistake, of course, was that the garden roller was too smooth and it came to the surface much too easily. You really want a rough, heavy log that is difficult to move – one that won't roll, and if the soil is very loose we won't even rest content with it, we'll bang a couple of pickets across the top of it underground, lash them together and fill in the whole lot with earth and trample it down. Well, now, you may want to build, very reasonably, a bridge over marshy ground. And here, in theory, you can use a Dead Man's Anchorage, but it is a very complicated thing because every time you dig the hole fills with water – a bit messy; not really very satisfactory. So I have a drawing here of a third sort of anchorage which I think will do the job rather better. It is really a combination of Dead Man and Picket. You will see from the drawing that we are using a heavy log that will rest **on** the surface but will also dig into it. Our main ropes come on to the log. A set of pickets hold the log against the strain of the main rope and themselves are supported by a back set of pickets on the far side of the log. Quite simple to make and really very effective indeed, but in marshy ground you may well need a very much longer picket than you wanted for our firm ground work, in fact somehow you must get a bottom – something far a picket to drive into.

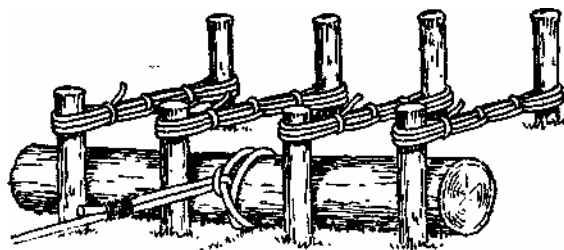

Well, there are the three ways I have suggested. Combinations of them and your own ideas, your own imagination, built on the experience you have had will add many more, but I am concerned to give you basic ideas and good sound principles to work from.

Perhaps this is a chapter where we can deal with other etceteras of pioneering. Things which crop up very often which I don't want to have to mention each time we come to a bridge or other project.

Let's deal first of all with a hook. Yes, the hook; he crops up pretty regularly whatever we are building. Usually the hook on the end of a pulley block, maybe to hold up the bosun's chair, maybe for all sorts of purposes. Well, it's a nice secure-looking thing, yet how often does it spell disaster. It's really amazing how Scouts will build a bridge, take infinite pains with lashings and knots, pickets, and all the rest of it, and then forget to mouse the hook. Really all the trouble they have taken with the rest of the job is a complete waste of time because of

failure to finish off this simple thing. I've seen a chap have a very nasty crash out of an aerial runway, because the hook wasn't moused. I've seen block and tackle used for tightening a monkey bridge come adrift because the hook wasn't moused. Well, I am all for adventure, I think it's grand, but I really don't see the point of an adventure where you haven't even a sporting chance. It's such a simple thing. The drawing here shows quite clearly how to do it.

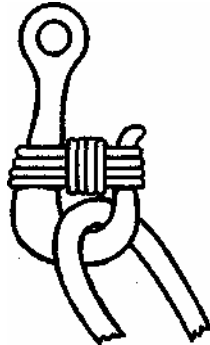

It means, in terms of gear, that you must always include in your equipment a few lengths of good stout cod-line, and that your Scouts are trained to put a whipping on and realise that often they will have to put the whipping on in a difficult position, because you can't mouse a hook until you have your chair or your rope or whatever it is in place: it must be one of the last things you do. If you forget to do it, well then it becomes one of the last things you never do! Quite seriously, though, this is really very vital. This is one of the things that the Scoutmaster himself looks at, hopes the Patrol Leader remembers too, but the good Scouter never lets a boy on a bridge until he is seen the hooks are moused.

Now let us pass on to something more cheerful. Taking the strain or tightening up the structure of a bridge or whatever it is. The simplest way and the safest way is by pulley blocks, normally a two and a one. Now I think that is not too much to expect people to master and, incidentally, give your Scouts the chance of "reeving", as it is called, the blocks themselves. That is, making up their own tackle, a two and a one. That really will give as much purchase as we shall normally need. You can go a bit further and have a two and a two, or a three and a two, or even if you like a four and a four, but it is not really necessary. Two and one will give you as much as most of us will need. The drawing here shows quite clearly how to this type of pioneering gear.

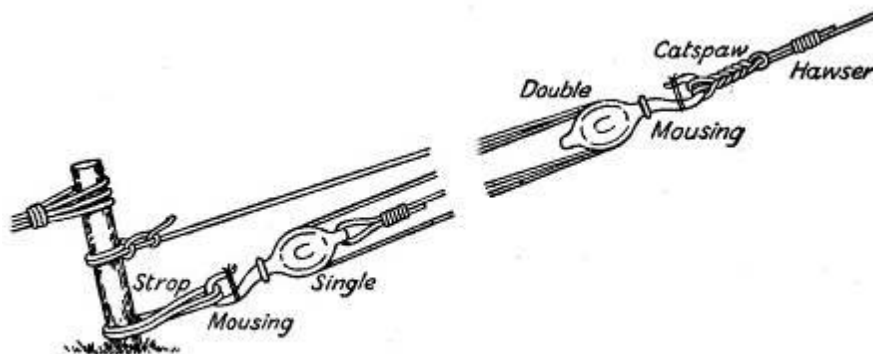

Note that the Double Block, the "two", is nearest the Rope it is straining.

But the drawing doesn't show, and can't very well show that whenever you have tightened up your bridge you must also make fast the loose end that comes out of the block. Take it back to the picket, lash it securely or, in some cases, keep Scouts holding on to

the rope so that the strain is permanently taken up. Very vital to make this fast otherwise the thing acts as a sort of catapult, as soon as anyone gets on it, all the slack you have taken up shoots out again and somebody is for it!

Then there is a Spanish Windlass. It is a grand old method, this. The drawing is, I think, fairly clear, but here again there is a bit of risk about it. While you are tightening that rope round the pole somebody's attention is distracted, somebody slips, one end gets free, somebody can get a frightfully hard knock with the butt end. Try it on a small scale in the Troop Room just with half a Scout Staff and some sisal cord. You'll see how it will take up the slack and you will also see the tremendous force that the stick has when it is released. Now this means, again, great care in using the Windlass and also the need to fasten the ends very securely after the slack has been taken up. The way I like best is to have loops of stout cord, grommets really (that is a rope spliced into itself), slipped over the main rope so that as soon as we stop turning our bar we can turn those two grommets on to the pole. It can't move: it has taken up the slack: everything's secure. You may say, why is it necessary to take up all this slack? Well, the whole point really is this: that we are using rope, that is, a very elastic sort of a material, and especially with a new rope, it will stretch, and stretch, and stretch. The more we use it the more it will stretch and we must take up the slack all the time. That is quite in addition to the slack that will arise from the natural movement when we are using the bridge, that is, the movement of our knots tightening, our lashings tightening, because you can't get anything so tight merely by pulling on it as it will become by standing on it and putting your full weight down.

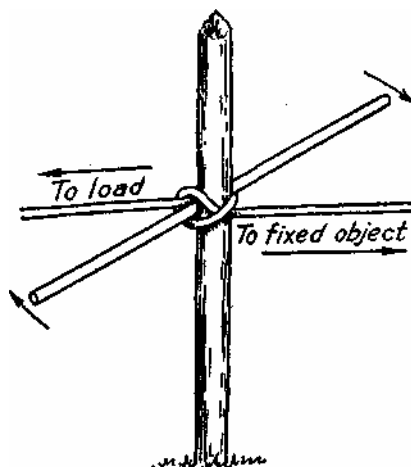

So whenever you have a bridge, a handrail, a runway, whatever it is that is going to take any amount of strain, there must be fairly frequent pauses for tightening, and one or other of the methods I have demonstrated will do the job reasonably well for you.

Well, there it is then. We have dealt with anchorages, hook mousing, and taking up the slack. They are all very vital. They are all things that the Patrol can learn to do without building a bridge at all. You can't learn to do them in the Troop Room, but on any waste piece of ground we can learn to drive pickets and, not least, learn how to get them out, and I hope you will give your Scouts the chance to become really proficient at this basic end of pioneering work.

Chapter VI

PROJECT NO. I: COMMANDO BRIDGE

GEAR REQUIRED

Two 3-Inch hawsers (just over width of river). or One 3-inch hawser (over twice width of river).
Sacking for trees.

THIS is really the simplest, worth-while pioneering project I can think of. One that uses the least possible amount of equipment. All we want is two ropes or one rope. Let us assume we have got two.

Now let us look at our questions – the ones we have already discussed in a previous chapter.

(1) What have we to do?

That is, what are we going to try to achieve? Well, that is obvious from the drawing. We are going to fix two ropes across a stream on to trees so that we can cross with our feet on one rope and our hands on the other rope.

(2) What do we need to achieve it?

That is, a list of equipment. We need two ropes approximately one and a quarter times the distance between the two trees. If they are longer it doesn't matter a bit – don't get cutting them! We also need some old sacking or old tent canvas or anything – just something to stop us bruising the trees.

Incidentally, I should like to suggest to you that in any pioneering project when you work from a drawing, look at the illustration and take off what a surveyor would call "A bill of quantities" which, in the case of this particular project, would read as we have at the head of the chapter. It is always a good thing when you are building something to know exactly what you need to do it with. You won't always have just what you want – that's where improvisation comes in: that's where you may have to do quite a lot of thinking and quite a lot of experimenting – but unless you know *what* you want, you don't really stand a chance of succeeding at all. So always begin, in this very simple project and in the more complicated ones we shall work up to, by taking off that "Bill of quantities", that "What do we need?"

(3) Where are we going to do it?

As this is a bridge, the obvious place is over a stream or pond, and I am going to suggest to you, right at this early stage, that when you have a stream to bridge the only fair and really adventurous way of doing it is to start with your Scouts and your gear on one side of the stream and, having built your bridge you all get across to the other side. It seems to me so very artificial to send half your Patrol to one side of an imaginary or a real stream and then bridge as though the stream isn't there at all. Let's be realistic. Let's really tackle the problem that we are faced with; and if we're not really faced with the problem then let's imagine we are.

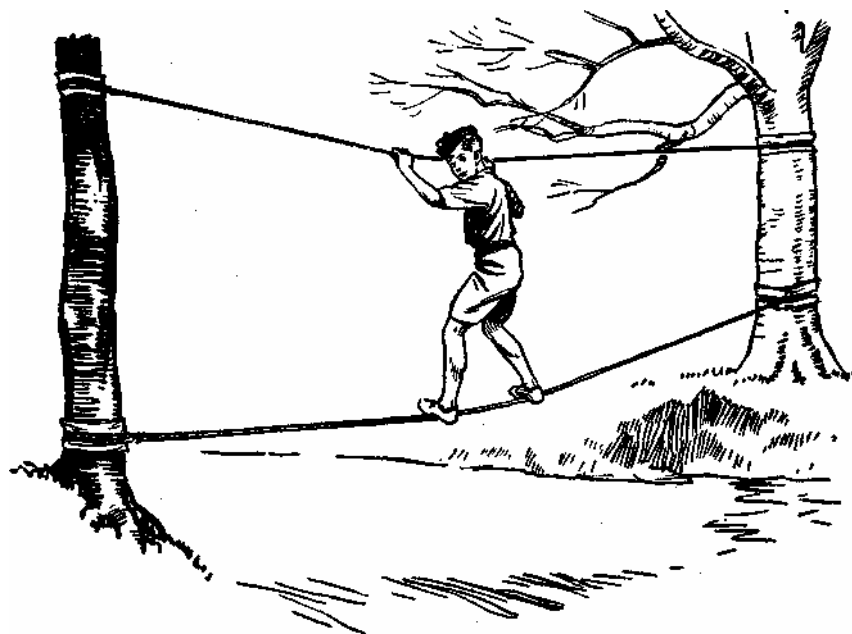

(4) How long have we got?

Well, now, I can't possibly answer that, and just by sitting and reading a book you can't answer it either! But I think it is a good idea to set a target – a target, perhaps, that is a little more difficult to achieve than in our innermost hearts we think we can manage. It is very good for you, and it is very good for the Patrol Leader to be put a little up against it. With an average Patrol – not very experienced – you want about an hour to an hour and a half to achieve success in this particular job. *You* may look at the drawing and say, “Ah! We can do that in ten minutes!” and perhaps you could, but I wonder if you can do it in ten minutes in the way I am going to suggest.

(5) Who is going to do what?

This is for the Patrol Leader to decide, as he will be acting as foreman on the job. He will say, first of all, who is going to get the rope across, and who will be the chap to go hand over hand first of all. This brings us to –

(6) How are we going to do it?

If we are going to start with this Commando Bridge having our ropes and Scouts on one side of the stream, the first question is “How are we going to fix the first rope to the tree on the other side?” Well, there are lots of ways, and luck enters into it as well as skill. The tree on the opposite bank – the one the artist has drawn – seems fairly typical to me, not a particularly helpful one. A weight on the end of one of our ropes (by weight I mean perhaps more bulk than weight), a stave or a couple of staves. Fling them over and try to get them to wedge in one of the branches so that they are safe enough for one of the more-agile and less-weighty members of the Patrol to go hand over hand to the other side. Or you may try a sort of in-swinger's shot. Fix a weight on your line again on a light piece of string (sisal or something of that sort) and go up the bank a little and try to toss the weight round the bole of the tree and then, with staves lashed together or strong poles cut from a nearby thicket, try to rake the weighted end back over, and then pull your rope round the tree afterwards. That ought to enable you to make fast so that you can get one chap across. Once you have one Scout across the rest's easy.

But just let's look at the job – look at it carefully. We want two ropes and we want them at approximately the same degree of tightness, especially does the bottom rope need to be tight,

otherwise it is going to sag, and sag, and sag, so that the top rope (the handrail) goes almost out of reach.

Then there is the sacking round the tree. That's very vital. Whenever you are putting rope on to living material make sure the living material is protected. Particularly see that the tree is protected on the back side, because it is there the greatest friction is going to be.

As to the knots you will use, well I think a round turn and two half hitches is as good as anything in each case. A clove hitch would do, I suppose, or a fisherman's bend – it doesn't really matter much what you use as long as it is safe. I don't think I would use a bowline: it is rather an awkward place to tie it and, anyway, I should feel happier with a double length of rope round the bole of each tree.

In the picture we have shown the bridge fairly near the stream level, but if we are going to be adventurous let us, the second time we build it, put it higher up with the footrail on the level where the handrail is shown in the drawing.

Then let's begin to expand a little – strengthen it and thereby span greater distances, by putting thin ropes or Scout staves between the main ropes at intervals along the path.

Lastly, a word about how to cross. Notice the boy who is on the bridge has his instep planted firmly on the rope – not trying to go on tiptoe (which is dainty but dangerous!) neither is he trying to go on his heels – but he has the broad part of his foot across the rope, he can almost grip it, and it is no bad thing to get Scouts to use their feet.

Well, there it is. This is a simple enough job, but there is quite a bit in it. I hope you will enjoy the making of it, and I hope you won't turn over and say, "Oh, that is too easy!" because some of the things we are going to build up to are very complicated and I hope in your Troop and your Patrols you will build up from these small beginnings which will help to implant very firmly into the Scouts the important basic principles of pioneering. Until you have learnt to fix one rope properly and securely, well then it is no use trying to fix two ropes – still less spars, blocks, tackles and the like.

So good luck on your first endeavour; don't rest content when you have done this one, but do have a shot at it. Please – when you have done it – don't stop; don't leave it there. There are all kinds of additions you can make, and believe me there are many games that are adventurous and darned good fun that you can play on a Commando Bridge. May I just suggest for your consideration two good large mops and old clothes for the Scouts?!

Chapter VII

**PROJECT NO. 2:
LIFT AND ROPE**

GEAR REQUIRED

Ropes:

One 2-inch or 3-inch hawser,
twice as long as width to be spanned.
One 2-inch at least 60-foot.

Pickets :

Three.

Blocks: Two double sheave.

Lashings:

Four 15-foot picket ropes
and chair ropes.
One 10-foot.

Oddments :

Sacking.
Maul.
Plank for chair.
Sisal for mousing.

(1) What have we to do?

TO fix a rope as high in a tree as possible; build a lift so that we can get on to the rope; fasten the rope securely on the far bank of a stream sufficiently away from the bank to ensure we don't droop in the water on the way across. Get the Patrol across the rope to the other side.

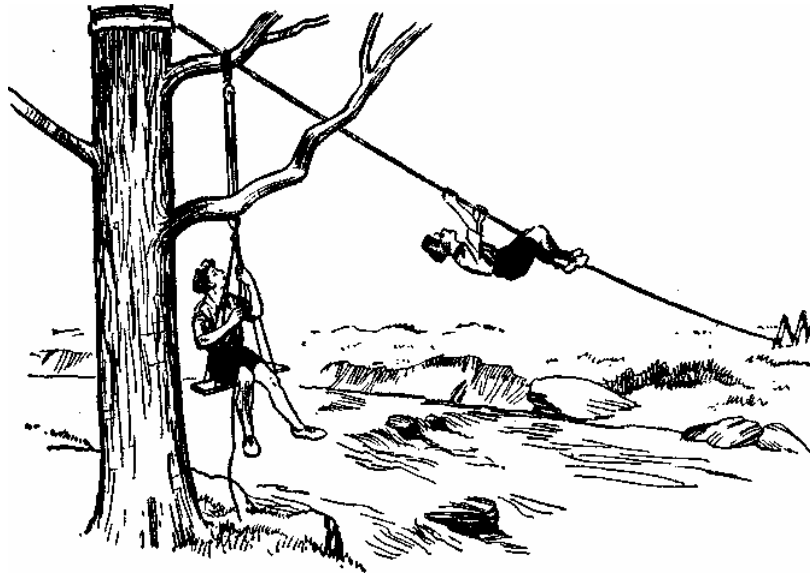

(2) What do we need to achieve it?

That is covered by the "Bill of Quantities" at the top of the page.

(3) Where are we going to do it?

Once again, do survey the site carefully before you start building the project: width of stream, type of soil, suitability of soil, trees to use for fixing – no overhanging branches.

Is there a clear run or have you to lop or tie back branches; have you to move anything out of the way before you start?

(4) Mow long have we got?

Not too long, I hope. This particular project built and in use and all across, 45 minutes for a Patrol of six.

(5) Who is going to do what?

Requirements: Scout to climb tree. Scout to swim or wade stream. Scout to make bosun's chair. Scout to reeve rope into pulley blocks. Scout to test bridge. P.L. to take charge.

The obvious is not always right. It is obvious to send your lightest man to test a bridge, but in our Patrol probably the lightest Scout came up from the Cubs last week and it is expecting a bit too much to make him the Patrol guinea-pig. No, this is a job for number three or four. The Second ought to get across the stream, possibly with another Scout to help with the pickets and number three or four up the tree, perhaps both if there is room.

(6) How are we going to do it?

Climb up the tree; fix the sacking in place to prevent the rope scarring the bark – if the sacking is a bit short it is more important to have it on the “away” side from the stream and on the top side of the branch; fix the sacking with sisal – it's a cumbersome business tying sacking on with heavy rope and consequently a waste of time. P.L. indicates exact spot to fix rope and also to put in pickets. The P.L., acting as foreman, is very necessary, otherwise Scouts will tear round and get everything in the wrong place.

The main rope fixed with a round turn and two half hitches or, for preference, a fisherman's bend; pickets in at an angle of 60 degrees to ground and ropes coming off the top of one to bottom of next. If you have them, put in three pickets at the front, then two and one at the rear, but the number and size of pickets depends on soil. You may not need any: there may be a tree or stump on the opposite bank.

Number five has been trying to get the bosun's chair made, the P.L. watching in case he's forgotten the scaffold hitch they learnt at Patrol Meeting last month. The Tenderfoot meanwhile is getting rather involved with the pulley blocks, but the P.L. will help sort that out. Finally, all is ready. P.L. inspects knots and all holds, and casts a special eye at the mousing of the hooks and we're all set for a trial run. Number three has it by half a stone, comes down the tree, gets into the chair, feet first, and pulls himself up – always a pleasant experience, and lands on a convenient branch – we made it convenient by fixing our ropes where we wanted them, and sets out on the crossing. P.L. a bit anxious. Second keeping a watchful eye on his pickets and standing by with maul.

How to cross? Well, let him Work it out for himself. There are four ways. As the drawing shows; or face down, feet first; or face down, head first; or face up, head first. Let them try for themselves. Personally, I'd wear stockings for this kind of crossing – the artist is more thrifty.

What else to say? Two things, I think. In getting the main rope across try to keep it dry and, if necessary, use it to get a Scout up the tree before it is sent across the stream. The other – clearing up: all dry, all neat, all accounted for; site inspected and tree checked and any bruises greased.

Finally, a challenge to the bold: fix your crossing rope with a draw hitch, or better still a clove hitch over a bight, and pull the rope over after you; good fun, but choose the right rope!

Chapter VIII

**PROJECT NO. 3:
RUNWAY SIMPLE**

GEAR REQUIRED

Ropes:

One 3-inch hawser (more than width of river).

One 1-inch rope at least twice width.

One 2-inch 60-foot.

Lashings:

Two 10-foot.

Blocks:

Two double sheave.

One single sheave.

One single snatch.

Oddments:

Sacking.

Sisal for mousing.

THE last chapter taught us something about the use of block and tackle to lift a weight – in that case ourselves – vertically. In this project we are going to use a block and tackle but this time horizontally. There are no other ways of using it – once we have mastered those two basic uses we ought to understand it thoroughly.

This particular idea, which I have called a simple runway, is something you could make very quickly and as you see from the list above, with really a minimum of equipment. In fact, all you need is a block and tackle, two more blocks and one good length of stout rope.

Well, now, how are we going to set about it all?

(1) What have we to do?

Erect a rope across a stream and fix to it a bosun's chair and have a method of tightening the supporting rope after each trip. Not very much to it, really.

(2) Where are we going to do it ?

Well obviously you must choose a stream or a bridle path or some crossing where you have some reasonably convenient trees. Though I might perhaps point out that the tree that is holding the block and tackle isn't really necessary – you could achieve much the same effect, though it would take a little longer, by driving in pickets, but there is a good reason to preferring a tree to pickets when you are working on the bank of a stream, and that is that near the stream's edge the ground is liable to be a bit boggy and not to hold very well. So if you can find the kind of situation the artist has illustrated, that is obviously the thing to do.

(3) How long is this going to take?

Not Very long. I think half an hour is all you ought to allow yourselves on this one. It is a nice job for a Patrol.

(4) Who is going to do what?

Here I think is an occasion where the first man either swims or wades across the stream with the rope. It is a good thing to vary things a bit and I think it is a fair idea on this

particular occasion. Anyway, somebody must get across the stream and make that main rope fast to the tree.

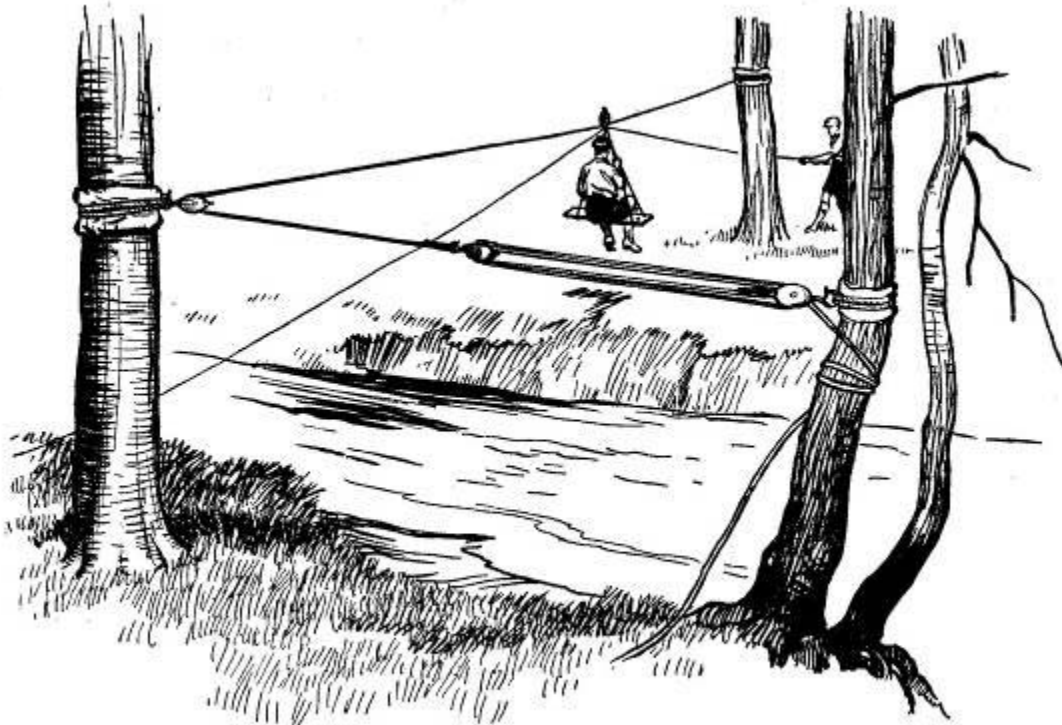

Simple Runway.

(5) How are we going to do it?

First of all, don't forget the sacking. As to the knot to use – I think a round turn and two half hitches would take a lot of beating on a job like this, though I must say I have always had a sneaking regard for the fisherman's bend. I know it is not in the simple Scout tests, but perhaps that is all the more reason for adding it on for ourselves. It is a very good knot and has a great many uses, it is very secure and it doesn't jam. So I think I'd plump for the fisherman's bend for this particular job. Fix it as high up the tree – this first holding knot – as you can reasonably manage. The higher the better really, because any rope, however tight you get it, is going to sag, and you don't want all your Scouts to make the crossing and arrive with dripping backs to their shorts.

While that is being done, of course, you will fix a strop round the tree on the near bank. Fix it securely, not leaving too much slack but leaving enough to insert the hook of one of your blocks. Fix that hook in and mask it; once again mouse it. Do it as soon as you have it fixed so that you won't overlook it. Put on a really good whipping to hold it firm. Then bring your main rope back through the block as the drawing shows and bend on to it a block and tackle. Two and one will do, or three and two if you have it. It doesn't much matter. Two and one requires a little more rope to pull it tight, but for this particular job that is quite adequate.

Well now we've made a mistake already – or perhaps we haven't! There are two kinds of blocks which you may have, one is the fixed block and the other the snatch block. If you have a snatch block, well you can do as I have suggested and then fix your bosun's chair on afterwards. If you haven't a snatch block, you must make sure to get that other pulley block

on to your rope before you make it fast, otherwise, of course, it is quite impossible to do anything except start all over again.

The bosun's chair we make as in the last project, using the scaffold hitch, and getting the chair a comfortable size, so that there is room to get in and we fix two guiding ropes on either to the top of the hook or, as the artist has shown, just above the hook but below the block. Personally I prefer them there, I think it gives better balance, but some prefer them on top. It is up to you to find out which suits you best. You can try one above and one below.

Now just a word about the use of this bridge. Very tempting when, as often happens, the bosun's chair isn't running as fast as the passenger would like, for him to put his hands up and try to help it along. And that means a tale of mangled fingers, because not only will there be the weight of the block but the friction of the rope can cause a very nasty burn. So it ought to be the order of the day for the man in the chair, "No hands on the main rope". This really is vital and it is the Patrol Leader's job to see it is carried out.

I hope you will experiment a lot with this simple kind of runway. Later on we shall consider the aerial runway, but if you master this one, when we come to the more difficult one you will find it all the easier to achieve success.

So when you have dealt with this simple runway at a fairly low level, gradually get it higher and higher from the ground until you really are riding from tree-top to tree-top and enjoying the experience.

Chapter IX

PROJECT NO. 4: THE SCOUT TRANSPORTER

GEAR REQUIRED	
Ropes: Two 30-foot I-inch for guys.	Spars: Three 12-foot to 15-foot. One 6-foot. Two 3-foot.
Lashings: Four 15-foot. Three 10-foot.	

HERE we come to a very good old friend. The list of gear at the top gives us what we need, and we really have not had to get anything extravagant so far. The drawing, I think, is clear and this is one of the ways that B.P. himself invented for getting across a fairly shallow stream. Perhaps rather obvious to remind you that it must be a reasonably shallow stream, otherwise you are going to need extraordinarily long sheer legs, so long in fact that you will never be able to move them. This transporter needs very careful handling, but it is a grand thing for testing out the discipline and team work of a Patrol.

I have known disasters to happen with the Scout Transporter, some quite serious accidents, and they are things to be avoided and they can be avoided if the Patrol works as a team and not as a bunch of individuals.



The Scout Transporter.

Well now, as to building. A pair of sheer legs with a ledger to secure them at the base. This in our projects is the first time we shall have had to make a sheer lashing, so let us go back to our earlier chapter where we discussed it and realise that this is one of the occasions where the sheer lashing is used for sheer legs, i.e. sheer lashing mark one, not done too tightly because it is going to tighten when we open the spars out. We are going to fix our ledger on with good square lashings, and then we shall need the two ropes we already have to act as guide ropes and a short length of spar lashed to form a V or, better still, try and find a natural growth that will act as a V and make a prop, because what we have to do when we have loaded our Scout on the transporter is to raise him up from ground level into the air, that is vertically, and then the strain is taken off the prop and taken on the ropes, and he is gently (I repeat “*gently*”) lowered on to the other side.

Well, now, what are the snags? Snag number one, I think, is that so often I have seen Scouts make a Scout Transporter without measuring the width of the stream. That is a fairly elementary thing to avoid, because if you don't get the width of the stream – and consequently the height of the sheer legs – the right size, all you do is to drop a succession of Scouts about six feet short of the far bank. Good fun, but not very good pioneering! So obviously we need sheer legs which, when they are in the water will be long enough to reach either bank from the middle of the stream. If our sheer legs are not long enough, well then we have either got to choose another stream or get some other sheer legs! Nothing else can be done about it because it is foolish making a transporter that won't transport.

Just how you make the seat doesn't matter. The artist has shown rope lashed round the spars. To lash another ledger on would do equally well and it is a very moot point which side of the seat to sit on – as the boy is shown in the drawing or sitting on the opposite side of the spar, but still facing the way he is going. The plain fact is that for half of the journey you are better one way and for the other half you are better the other way. You can either be uncomfortable to start with and comfortable at the end, or vice versa – it doesn't matter which.

Now I mentioned the potential danger. The real trouble is that props can slip and the Patrol Leader, if he is wise, in this project will keep a very shrewd eye on that prop the whole time it is taking the weight of the transporter. The advantage of this job is that it can be made very quickly indeed. It should not take more than half an hour of any Patrol's time to get it up and the whole Patrol across.

Of course, if you want to be ambitious, and I hope you do, you can add greatly to the use of the transporter by having guiding ropes on both sides, by having a prop on the other side of the stream too, because in that way you will be able to use it backwards and forwards and also you will be able to get all the Patrol across. If you leave the lightest chap until last, well then he can mount himself and all the husky fellows who have already crossed can pull the whole of the transporter up to the vertical and pull him across. But do remember that this is a transporter bridge: the idea is not to use it as a catapult and to send the smallest Scout in a graceful parabola over the trees on the far bank of the stream.

Just to summarise and to answer our questions.

(1) What have we to do?

Erect a Scout Transporter of the right size and in the right place and learn how to use it.

(2) What do we need?

Our gear, plus knowledge of the width of the stream and the composition of its bottom.

(3) How long have we got?

About half an hour.

(4) Who is going to do what?

Two Scouts on each lashing; Patrol Leader attends to prop himself.

(5) How are we going to do it?

That we've already answered.

One final word. If the stream is a swiftly flowing one, either build something else or weight the bottom of the sheer legs. Being swept away on top of a pole in mid-stream is spectacular but appeals to very few as a pastime, and isn't really very practical.

Chapter X

PROJECT NO. 5: THE HIGH HOIST

GEAR REQUIRED

Ropes:

One 2-inch 150-foot.

Spars:

Two 25-foot.

One 30-foot or two 20-foot.

One 10-foot.

One 6-foot.

Pickets:

Two.

Lashings:

Four 15-foot.

Six 20-foot.

Two 10-foot.

Blocks:

Two double sheave.

Oddments:

One plank for chair.

Maul.

(1) What have we to do?

THE purpose of this somewhat strange-looking erection is really many-sided. In the artist's drawing we see one use for it, that is to erect an apparatus that will enable us to lop a dead limb off a tree in safety, and obviously a very much more secure way than using ladders or – the very worst possible way – sitting on the branch we are sawing off, which has been done with disastrous results. There are, of course, many other uses for this particular project. You might want to get a party of Scouts up the side of an unclimbable cliff: equally you might want to lower them down. A slight adjustment will make the apparatus work from the top downwards just as from the bottom upwards.

(2) What do we need?

Our Bill of Quantities once again. We might make a general point here, though it ought to be obvious, but it is often overlooked – the longer the spar you use the much greater strain you are placing on that spar, and the old maxim that a chain is as strong as its weakest link applies very much to ropes and spars too. The longer the spar the more dangerous will that weakness become. It is always a very difficult thing, in pioneering, to get an exact balance between strength and weight. With experience you get better at it, but it isn't necessarily the heaviest thing that is the strongest, neither is it necessarily the waviest spar that is the weakest. That is a general point you must watch in this project and indeed in many others.

(3) Where are we going to do it?

Well there is unlimited scope here. I suppose the short answer is "where we are going to use it", but it may be (as we have found at Gilwell) you want a transportable one if you are going to do a lot of lopping, and we have used this apparatus with a considerable amount of success.

Incidentally, when you can make a thing anywhere and take it where you want to use it, try and choose somewhere comfortable when you make it: I mean an open place in the middle of a

field and not in the middle of bushes. Sometimes in our projects we have to work in inconvenient places, with rocks to get round and tree roots in the way, but this is one of the times when it doesn't much matter where we do it and it is, therefore, good sense to choose the most comfortable situation, because everybody works better and more successfully if the conditions are the best possible obtainable.

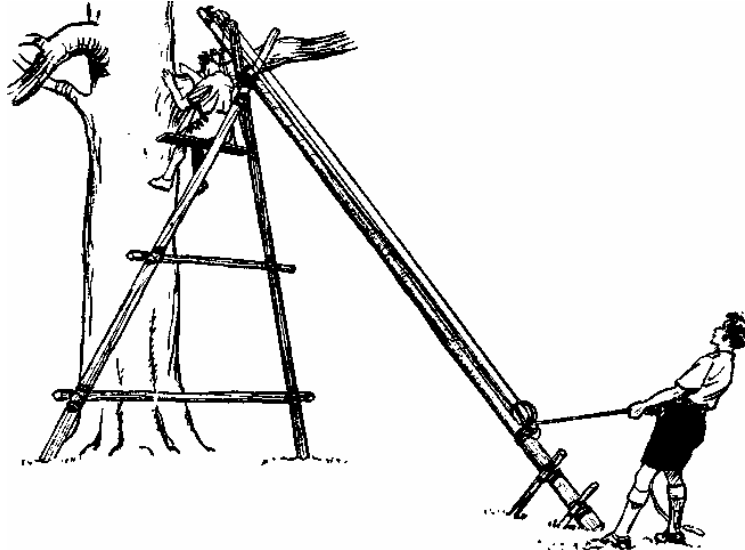

(4) How long have we got?

Well, this shouldn't take very long. Half an hour to three-quarters should be ample time for any Patrol.

(5) Who is going to do what?

We want a sheer lashing at the top of our sheer legs and four square lashings on the legs. The bosun's chair has to be rigged up and pickets driven in, and the blocks fixed to the supporting spar.

I think it is always a good thing in heavy work such as this to have two Scouts to a lashing, because it is necessary to have plenty of weight to get lashings tight. So if we have four Scouts on lashings they can divide them up among themselves. One on the bosun's chair – the Patrol Leader could rig that up and keep an eye on the other parts of his team, and one Scout fixing the tackle on the main spar.

(6) How are we going to do it?

I think we have really covered that. Sheer legs first, and don't forget when you finally come to erect them just nick the ground sufficiently to give a bit of a grip. You won't need to go more than a couple of inches, but it can make all the difference.

Just a word about the fellow in the drawing who is shown as cutting the branch away. Though up to a point he is safe, he is not going to be so happy when the branch falls. It is a good point to have a light rope fixed to the branch to pull away when it is ready to fall. As he is situated in the drawing he might get a nasty crack on the knee.

Incidentally, don't forget to put a saw cut on the side of the branch nearest the ground before the main work is done of sawing through.

Well, I think you will get a lot of fun with this project and I think it is up to you to find other uses for it.

Chapter XI

**PROJECT NO. 6:
AERIAL RUNWAY**

GEAR REQUIRED

Ropes:

One 3-inch hawser (longer than run).
One 1-inch rope (at least twice the run and height of tree).
One 2-inch 30-foot.
Two 1-inch 30-foot guys.

Spars:

Two 15-foot.
Two 6-foot.
One 4-foot.

Blocks :

Two single sheave (one snatch).
Two double sheave.

Pickets:

Five.

Lashings:

Four 10-foot.
Seven 20-foot.
Two 15-foot.
Twenty-four 6-foot cod-line for platform.

Oddments:

Sacking (saddle and tree).
One plank for chair.
Sisal for mousing.
Rope ladder or pieces.
Thirteen light poles for platform.
Maul.

(1) What have we to do?

HERE we come to the best-known and most popular of all pioneering projects. Infinite variety and grand fun, but nonetheless there is a good way and a bad way of making the runway just as there is in everything else. I think I would summarise the answer to the question "What have we to do?" by saying, "Make an aerial runway that works." I have seen so many that *nearly* work. I have seen a lot more that work sometimes. I have seen one or two that work almost too well, but I will come back to that in a minute.

(2) What do we need?

Well, the gear we know about. There is one other thing that isn't exactly gear but is important, and that is a reasonably convenient tree. It is true to say one can do anything given enough ingenuity, time and materials, but we are usually short of one of these things, and in Scouting, which after all is training, we are learning to pioneer in the first instance. We haven't *got* to get across that river – it is just that we want to, and if that is the case let us try to find a reasonably situated tree that has a few branches sticking out where we want them.

(3) Where are we going to do it?

That is almost answered by the last paragraph, but there is another point. You do want a clear run. It is quite exciting careering down through a mass of foliage, and birds' nests and squirrels, but it is bad for the complexion.

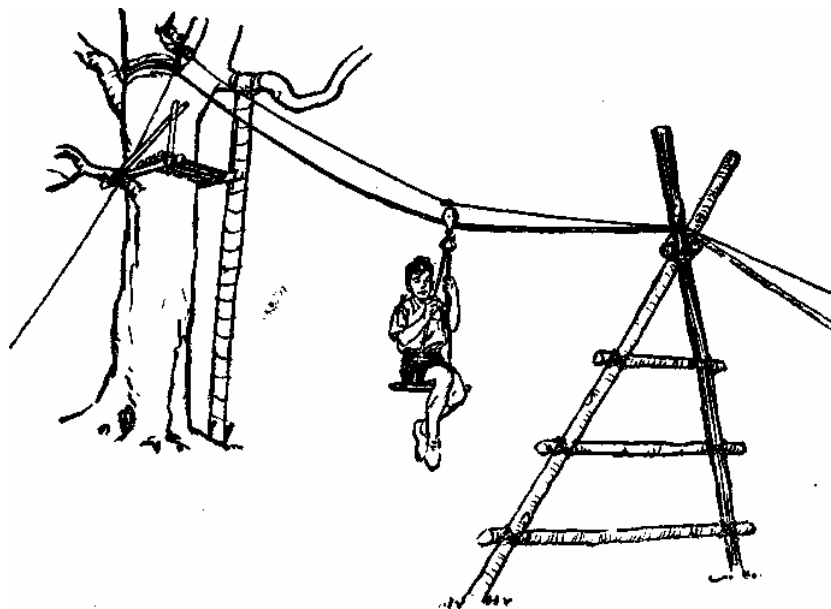

(4) How long have we got?

This is a project that always takes longer than it looks, as though it ought to! One of the reasons is that some of the work has to be done up a tree and, practise as we may and good as we may become, nonetheless it takes a bit longer to make a knot or fix a lashing 20 feet above ground than it does if you have both feet firmly planted on terra firma.

I think for a runway we ought to allow one and a half hours; in some situations two hours or even two and a half hours.

What I would impress on Scoutmasters is that the further we get above ground the greater the danger and the greater care we must take to ensure that lashings, platforms, poles, etc., are in really good order. Let us put it this way and go right back to our first project, the Commando Bridge, 2 or 3 feet above ground level. Well, if this slipped, at the worst you'd get a ducking with perhaps a bruised elbow on a stone in the stream – quite a good experience. When we look at our runway, though, if we have a drop from that because a hook isn't moused, or something like that, well, from 20 feet above ground it may well mean a broken leg or arm, or, worse still, a badly damaged back. There is no danger in these things if we do them properly but there is danger if we are slapdash and careless, so as a general rule the higher above ground we get the longer we take and the more careful we are, checking every single piece of work.

(5) Who is going to do what?

Here, I think, we break down the job into five:

Sheer legs.

Our anchorage which is not shown in the picture, but you can use either a Spanish windlass or a block and tackle. (The gear list includes for the latter.) It must in this job, incidentally, be an anchorage you can tighten as the rope will stretch as the runway is used.

Then there is the work in the tree, with the platform which is usually necessary and for the fixing of the main rope to the tree.

The bosun's chair.

Finally, the ladder.

So there are five things to set up and all of them require two Scouts at least. Here, in fact, is a grand project for two Patrols. One Patrol *could* do it, but twelve Scouts together will have plenty to do and the two Patrol Leaders can supervise and do the testing.

(6) How are we going to do it?

Well, first of course the line. You must know exactly where you want the runway to run from and to. "To" is fairly easy, but "from" may not be quite so easy. I have mentioned already how difficult it is to come sailing through the air when you can't see where you are going because you are in the middle of the foliage and branches of the tree. You may have to do some gentle pruning or tying back. And then so many runways I have seen have a ladder starting about 5 feet above the ground, and I said something earlier about avoiding designing things for use only by trained acrobats. Have the platform erected on the tree so that you can get from it and into the chair with a fair degree of safety. These things very high above the ground should not be only for the P.L.s, and the big chaps, but for the little fellows who will get a wonderful thrill out of this kind of thing provided it is a reasonable proposition. The platform will need to be a bit more secure than the one the artist has shown. I am not quite sure how he keeps his up, but yours is up to you.

Then the ladder. You will notice it is fixed at the bottom. You can have just a rope if you like, but that is not much fun for the eleven-year-old just up from the Cubs, so have a ladder, and it will need to be properly fixed at the foot so that when a fairly heavy weight is on it it remains fixed. You try it yourself. It is a very alarming thing to be half-way up the ladder when the fastening at the base comes adrift and you are left swinging in the breeze like the pendulum of a clock. We must have enough ledgers so that when we get to the other end we can get off the chair. That is equally important.

I remember leaving a nice secure platform, sailing through the air, and arriving at the sheer legs very high above the ground, and as far as I could see I was going to spend rather more of the next few hours up there than I had bargained for! There just isn't any way of getting off! Quite entertaining, but not good pioneering.

Then we have got to provide a means of slowing down, otherwise you come along at such a speed that you literally flatten everything, face, chest, legs, and even the sheer legs, and that is not a very happy arrangement. I think the best way of slowing down is to have the main rope just off absolute tightness, so that the weight of the body on the chair causes it to sag just before it reaches the sheer legs. You will still come down at a good pace, but not so good that you hit the buffer and go right up through the platform.

In order not to clutter up the drawing too much the artist has left out guy lines on the sheer legs. I am going to leave you to work out where to put them.

There is another danger in this project, and that is the danger of the sheer legs collapsing. I mean when the weight comes off the tree and on to the sheer legs, they may come right over to you as you approach, and it is a very sorry end to a ride on the runway to find yourself being lowered rapidly to the ground and as you reach it for the sheer legs to come over and crack you on the head! It is no use to say "That won't happen to us." It will happen to anybody who doesn't take precautions to build the runway properly.

Just a few points to round off. Don't forget the sacking where the rope ladder is fixed to the tree and where the main rope is fixed to the tree. Don't forget the guide rope to be attached to the top of the pulley block so that you can get your chair back. Make sure that your pulley block is kept oiled, otherwise you won't be able to get it back. Try to give yourself plenty of room with this job. I remember seeing a grand runway with 150 feet of actual run and it was fixed right at the top of trees about 50 or 60 feet above the ground – it really was a fine show. But

don't you start up there. Start nearer the ground, but aim higher and aim to get the runway longer.

Lastly, remember there is a fair amount of strain on the rope in this project, so always inspect the rope both after you have used it and before you use it again. I have already mentioned about owning rope up to inspect it and not just being satisfied with its outward appearance.

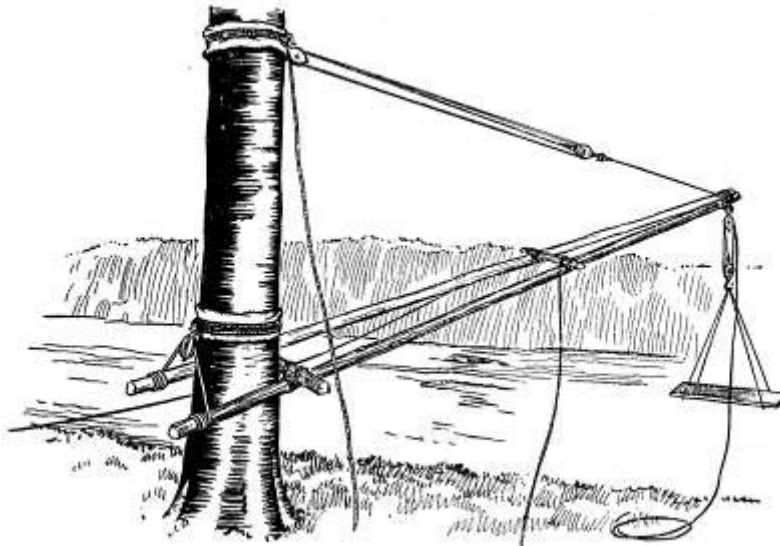

Swinging Derrick on a Tree.

Chapter XII

PROJECT NO. 7: SWINGING DERRICK ON A TREE

GEAR REQUIRED

Ropes:

One 2-inch 60-foot to 100-foot.
One 2-inch 50-foot.
Two 1-inch guide lines approx.
60-foot.

Spars:

Two 12-foot to 15-foot.
Two 3-foot to 5-foot.

Pickets:

Two for anchoring guide lines, etc.

Lashings:

Seven 15-foot.
Three 20-foot.

Blocks:

Two double sheave.
Three single sheave.

Oddments:

Sacking for tree.
Plank for chair.
Sisal for mousing.

IN this project we have a number of moving parts. Without being technical, this means friction, and our knots and lashings must be even more secure than they need to be in a static affair.

The derrick the artist has shown was based on a tree, and I would remind you of my previous remarks about the safeness of trees, particularly to avoid the dead tree (unless perhaps it is a dead oak): avoid the crack willow; certainly avoid the elm which is dangerous to use for pioneering, and keep away from trees that have woodpeckers in them. The woodpeckers will not interfere with us, but they are a sure sign that the tree has started to decay and it is very possibly hollow and liable to break. Now for our questions.

(1) What have we to do?

Using a tree as a base, erect a swinging derrick which will enable a Scout to be transferred from the bank to a raft or boat in the stream.

(2) What do we need to achieve it?

Here again, the list of equipment at the beginning of the chapter gives the answer. I know that five pulley blocks is rather a large number; there are very few pioneering projects where you need so many, but they are not expensive and they have an incredible number of uses.

(3) Where are we going to do it?

Well, do survey the site first.

(4) How long have we got?

With a Patrol of six this job should take sixty minutes.

(5) Who is going to do what?

The *modus operandi* for the job is as before, the Patrol Leader being general manager and foreman.

(6) How are we going to do it?

The first job is to fix the two pieces of sacking in position. The Scout staff to lift a Scout to a sufficient height on the tree will be found useful. Fix the top sacking on with sisal and over the sacking fix a rope strop. Meanwhile, one Scout can be making a bosun's chair, but not quite as the artist has shown it. Use a scaffold hitch at each end of the plank. Two Scouts can be making the jib, using a sheer lashing at the top, kept apart with a wedge. Square lashings are needed for the two crossbars. Two other Scouts can each be reeving the two pairs of blocks, one for the bosun's chair and the other to carry the jib. As soon as the jib is completed, secure one block by its hook to the strop round the highest point of the tree and make fast round the sheer lashing on the jib, working, of course, not over the stream but over the land. Then secure the base of the jib. The method shown is a good one, but you can do without the block and just use the rope, or you can, although it is not very satisfactory, have a further cross-bar at the back of the tree and let it pivot on a post driven in alongside the tree. This is a nice enough theory, but tree roots take some driving through. Then fix the bosun's chair to the top of the jib, join on the two guiding ropes to the spars mid-way along the jib and the job is done.

Before the derrick is used the Patrol Leader, as always, must check everything, testing the lashings and paying special attention to the mousing of all the hooks; our artist has left these out of his drawing and has been a little too adventurous. Test the security of the whole thing over land before you venture out over the water.

This derrick has, of course, three quite separate movements. With the block and tackle fixed to the top of the jib we can raise and lower the jib as required ; with the ropes fixed to the jib we can swing it from side to side, and with the block and tackle fixed to the bosun's chair we can raise or lower the chair. This can either be done from the bank or, in Scouting, it is probably better for the chap sitting in the chair to work it himself. Personally I have a marked preference for keeping some control over the situation.

This derrick as shown is a fairly simple thing. It needs to be done thoroughly and, of course, it is only a small advance from this to building it without using the tree, but that is our next project.

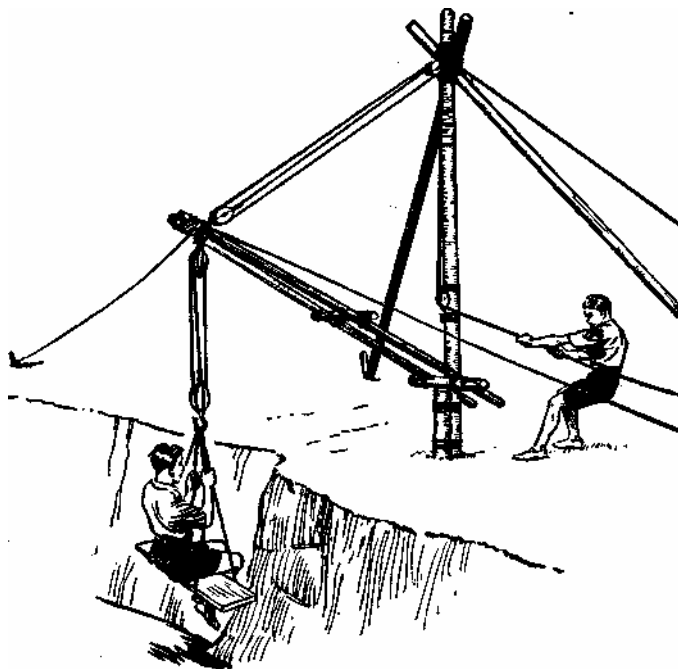

Chapter XIII

PROJECT NO. 8: SWINGING DERRICK

THIS follows quite obviously and logically from what we talked about in the last chapter, and I don't think there is any need to go through our detailed questions on this occasion because there are really only two points of difference. We are replacing the tree by a spar and it really must be a sound and secure spar; in fact, in your gear you really want a special spar, and it will want a good anchorage with two supporting spars to hold up the main spar and to ease some of the strain, and these in turn need to be fixed firmly to the ground with pickets. As to the hoist, you can either drive in a stake as the artist has shown, or you can use the pulley block method that we saw in the previous chapter. I have deliberately shown you another method here because it adds variety and it adds experience too, to have more than one way of doing it.

We must have a man on guard who keeps an eye on all lashings, all strains, all pickets, all blocks, because here we have got a great number of moving parts, and moving parts mean

friction, and that means varying strains which potentially are more dangerous than immovable strains.

A lot of fun can be had with this derrick, especially if it is built on the side of a stream which runs well below the level of its bank or, indeed, on the edge of an old quarry or pit so that the chap in the bosun's chair can go down some distance.

Finally, it is a very good experience for a Patrol to work a thing of this sort. Four Scouts are always actively engaged, and possibly five. They must work as a team, otherwise the chap in the bosun's chair will have a very uncomfortable passage. I hope you will try this out in practice but, again, don't leave it at this. Develop it, improve it, combine it with other things. An obvious combination is the derrick and a raft, and if the stream is swiftly flowing it is no mean feat to time the landing from the chair to the raft and vice versa, and if your timing is bad nothing worse than a ducking will result.

Chapter XIV

PROJECT NO. 9: THE MONKEY BRIDGE

GEAR REQUIRED

Ropes:

One 3-inch hawser more than span
between legs.

Two 2-inch hawsers more than
span between legs.
or

One 2-inch hawser double length.

One 2-inch 30-foot for tackle.

Spars :

Four 15-foot.

Two 6-foot.

Pickets :

Six.

Lashings:

Ten 10-foot.

Blocks:

One double.

One single.

Oddments :

Sacking.

Sisal for mousing.

Maul.

Light poles or cords

for stays.

Spade.

I EXPECT this will be familiar to most of you. You have probably had a shot at it – you may have met with some measure of success, and you may have had a bridge that really looks as though monkeys had built it. I am afraid all too many turn out like that!

It is rather a misleading fellow, this one. The trouble is that it looks simple and it is simple, but it is not as simple as it looks. There is a great deal of work to do. There is a great deal of accuracy called for. There is a very great deal of lashing and measuring – in fact, here is a bridge where we have to be really thorough, and that is why I have left it till well on in the book, because I don't think this is an elementary project at all.

What one might call a second-year one – not merely because more gear is required, a bit more than the other projects we have attempted, but because a great deal more experience is necessary if we are going to be successful. I think we can leave most of our questions on this occasion, but I will try to answer them briefly, and try to expand on how we are going to do it.

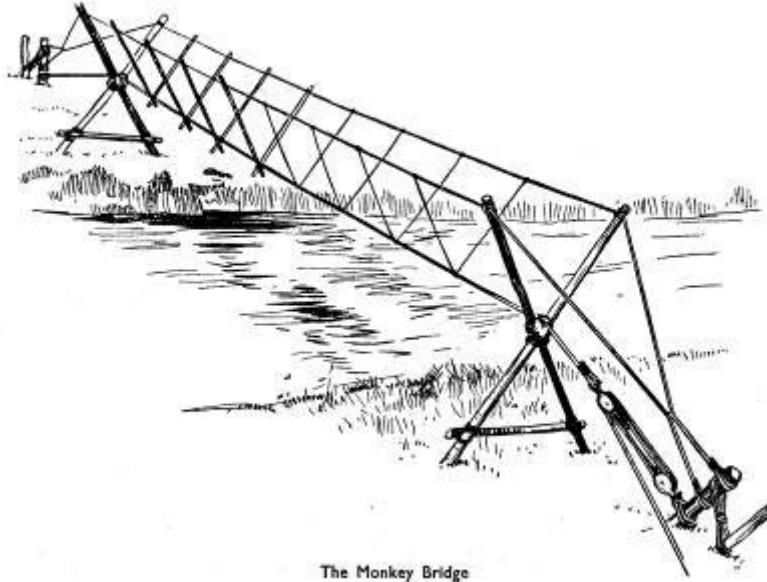

(1) What have we to do?

To throw a bridge across a stream, mounted on two trestles, a bridge made of one main rope and two handrails, supported either by staves or by cord. The bridge to have some means of tightening at one end – preferably at both ends.

(2) What do we need?

Our list of gear. We need the spade to dig those sheer legs into the ground a bit. Width of the stream very accurately measured, and will you notice right at the start that the bridge starts on dry land and finishes on dry land. We haven't made the mistake – or at least the artist hasn't – of sticking the sheer legs in the water and making it almost impossible to get on to the bridge with any degree of security.

(3) How long have we got?

Well, I don't know – but *please don't hurry* ! This does take time – this is a whole morning's work. You can't do it in half an hour, and bridging of this sort requires patience and real attention to detail. Never make it a race. Many of the other things we have put in this book you can race with, like the Simple Runway, even the Aerial Runway, but not the Monkey Bridge.

(4) Who is going to do what?

This can well be a two-Patrol job, one Patrol on one side of the stream, and one on the other. Or three Patrols if you like; in fact three, I think, is best. I would divide it up this way. Two Patrols, one each to make a trestle and get them in position. The third Patrol to be responsible for making the roadway itself, that is the roadway and handrails complete. But the more Patrols you have the more chances there are of making errors, so we come to –

(5) How are we going to do it?

First let me say we are going to get those two trestles the same size. But wait a minute, that might not be right. That presupposes that the stream is level – well, of course the stream will be level because water finds its own level whatever we may think – it presupposes, though, that the banks are level. It might be a situation where one bank is higher than the other, in which case you would adjust your trestles accordingly. But let's assume the best, and for our first attempt let us find the best conditions, build where the banks are level and make our trestles exactly the same size.

Suppose we have two Patrol Leaders in charge, one on each bank. They will act as foremen, they will compare notes, they will measure with their staves and get the size exactly right before a lashing is put on anything.

The trestles themselves, sheer lashing at the cross, square lashings on the ledger at the bottom. Sheer lashing not too tightly put on so that when we open out the legs the lashing will tighten itself.

So to the roadway. Now in the first place we need the distance from the top of our trestle to the crutch to be almost exactly the same as the distance from our handrail to our footrail. That means that the supporting pieces, string or staves (the artist has shown some of both), they too must be exactly the same as the top arm of the trestle, otherwise they are going to make the bridge a very peculiar and uncomfortable shape. In any case they must be all the same size and fitted on the same distance apart.

How to fit them? String first, clove-hitch round the bottom, that is round the footrail, and clove-hitches on to the handrail – as simple as that!

Staves? Lash them together first with a sheer lashing, open them out and place them under the roadway so that they help to support the roadway – not on top, under the roadway – and fix them on with a diagonal lashing. You really do want quite a decent diagonal lashing there, because the spars tend to move about. On top make a square lashing to the handrails.

You want a stave or a cord about every $2\frac{1}{2}$ – 3 feet. There is a way of doing it without any supports at all, but I will come back to that in a minute.

Now as to tightening methods. The artist has shown a rather original and probably not a very practical way of tightening the handrails. It is all right to start with, I have tried it, but it is difficult to tighten it up. It is much better really – there wasn't room in the drawing, I am afraid – if the handrail is brought back and joined on to the footrail on the back side of the trestle, and then the three ropes together are brought on to our block and tackle or Spanish windlass, whichever you like.

At the other end, the way the artist has shown, going back to a set of pickets is as good as any.

Other things to remember? Notice the sacking over the crutch of the trestle, preventing friction on the footrail and also protecting the lashing from being rubbed loose. Sacking and old canvas are indispensable to good bridge building. And, of course, the pickets ought to be rather farther back than the artist has shown, but that is not his fault, it is just that the page isn't big enough and we had to get it all in. Take plenty of room – as much as you have rope, in fact. Try sometimes using the block and tackle tightening, and on other occasions, for it suits the Monkey Bridge very well, try using the Spanish windlass.

Now one other way of doing it that I said I would come back to. Look at the bridge again and imagine all those side supports, staves and cords, are not there and all you have is two handrails and a footrail. You could cross, I suppose, just like that if the bridge were very well

made, but there is a simple way that I saw demonstrated at Gilwell some years ago, and that is to construct a frame of Scout staves, a triangle really, exactly the same size as the triangle made by the three ropes, and then with that framework in front of you you push along. You have something to lean on and it is a way of strengthening the bridge where you are, and that, of course, is the place to strengthen it. So just try that out. I think you will find it good fun and it is one of those original touches that is worth trying for yourself and, I hope, introducing at some time to other people.

So don't take this Monkey Bridge too light-heartedly. Don't think it is all easy, that there is nothing to it. There is a great deal to it, getting those two sides exactly even, getting the spacing of your staves and cord, getting your trestles identical and opposite each other, getting a true run from one set of pickets over the trestle and on to our tightening apparatus. All those things matter and only if you have them all correct will you get a Monkey Bridge that belies its name.

Chapter XV

PROJECT NO. 10: THE BUSHMAN'S BRIDGE

GEAR REQUIRED

Ropes:

One 2-inch hawser at least twice width.

Spars:

15 to 20 light poles, or 20 forked sticks.
10 or so short 3-foot poles.

Lashings:

30 light lashings (3 for each support).

Oddments:

1 rope ladder more than width of stream.

Sacking.

Maul.

15 to 20 tent pegs, If no forked sticks.

Cord or sisal for lashing tent pegs to poles.

THIS is a bridge I favour greatly. It is simple to construct and if you can get the right natural materials, then it really presents very little problem at all. Our list of material at the top shows an alternative. It depends very much on your opportunities, whether you can get enough forked sticks. If you can, well and good. If you cannot, well then lash on some tent pegs. You will have to lash them at rather a different angle from the one the artist has shown, but as long as they are big pegs with a good bit they will hold up all right. Well now, let us look at our questions.

(1) What have we to do?

Build a bridge from one side of the stream to another with a good substantial footway and a couple of handrails.

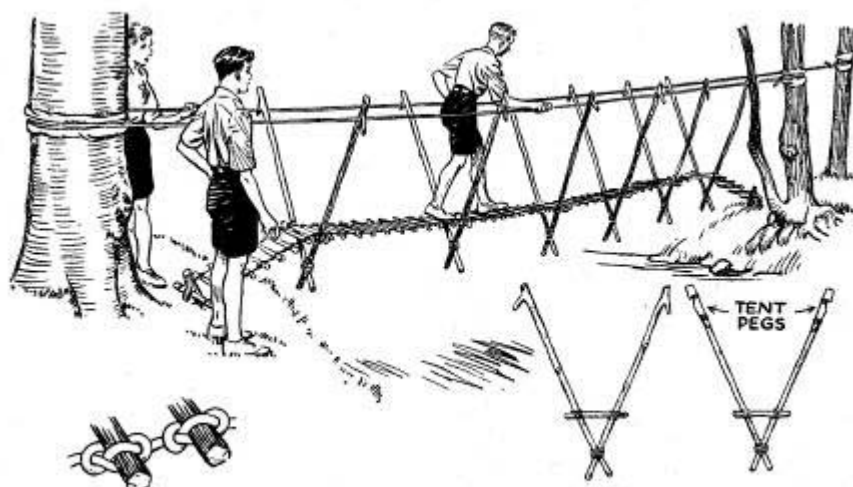

The Bushman's Bridge.

(2) What do we need to achieve it?

Our list of gear, of course, width of stream – don't forget that. Always allow a bit extra.

(3) Where are we going to do it?

A situation, too; we need this, where we have reasonably convenient trees. They needn't – and they won't – look exactly as the artist's, but with a little ingenuity any place where you have two, or preferably four trees, two on each bank, will serve our purpose.

(4) How long have we got?

I think this is an hour's job for a Patrol. Not more, but I think it needs an hour to do it thoroughly and satisfactorily.

(5) Who is going to do what?

Now here is a job that breaks down very easily. Two chaps to get one rope across to start with. Somebody will have to get across that rope Commando fashion before you can make fast your handrails. Two to prepare the trestles, as we might call them, that is, the bits that hang on the handrails; and two to make the footway, which is really a sort of rope ladder.

(6) How are we going to do it?

What else is there to say? Note the situation regarding our main ropes. Those can be two separate ropes or, as in the drawing, a continuous rope coming round a thick tree on one side of the bank off two thinner-boled trees on the opposite side. How to fasten them? I think the fisherman's bend is the knot here. A round turn and two half hitches if you like, but something that can be fairly easily undone because you will need to tighten up quite often. You could, of course, work in a block and tackle if you like at one end so that you could tighten without undoing, but that is a matter of choice.

A word about the rope ladder. Don't put the rungs too far apart and don't have the steps themselves too wide, because the wider they are the greater the strain on them and the more tendency there is for them to break. I think you want between the ropes a foot to eighteen inches, no more, that is quite sufficient. In any case you must make quite sure you measure the width of your ladder and the width of the crutch in your supporting arms.

They must be almost identical otherwise you are going to be in trouble. If it's too big the footway will sway about, and if it's not big enough, well then it can't rest on the supports.

Then those supports. The more of them the merrier, really. Forked sticks I hope you will be able to find, and you may want to fasten them. The artist has shown them just hung on, which I have seen used with good results without any danger. If you have to build the bridge any higher up, then perhaps a simple lashing or fastening them on with some combination of half hitches is necessary. That is a matter of trial and error, and I hope not too much error.

At the base you want a diagonal lashing, and square lashings to hold the small cross-pieces in place. There is quite a lot of lashing to this job.

Back to the rope ladder. Notice first that it is fastened by a crotch-stick at each end, notice too that the artist has shown the lever hitch or marline-spike hitch, which is very necessary and is really much better than clove hitches. But remember you are going to need a lot of rope, if you are going to put those marline-spike hitches all along the width of the stream. Roughly you will need twice two and a half times as much rope as the stream is wide, that is five times, because we have to have the rope each side of the ladder. It will be quite light rope. Not sisal, but something light, cod-line would do but there must be plenty of it. Those lever hitches must be pulled tight before you start walking on the bridge, and get them running as the artist shows. On one side of the bridge, right hand for example, get them running in the opposite direction to the left hand side of the runway. That will even up the strain and I think you will find that will be the most satisfactory arrangement.

If convenient trees cannot be found the bridge can be built using sheer legs.

Chapter XVI

PROJECT NO. II: THE LOFTED BRIDGE

GEAR REQUIRED	
Ropes:	Ropes (continued): For Ladder
One 50-foot 2½-inch.	Four 50-foot 2-inch.
Two 50-foot 2-inch.	Eight 10-foot 1 inch.
Six 25-foot 1½-inch.	Ladder rungs.

(1) What have we to do?

BUILD a safe and secure bridge as high above the ground as possible (and here is the snag), working from one side of the stream only. Now I do suggest you try to do it that way. I know it is easier to walk across, to go round by road or to swim across, or just to build a bridge and imagine the stream, but your Scouts are not going to get the full benefit; they are not going to be faced with a real problem and, above all, they are not going to have the sense of real achievement that they can have if the thing is tackled with ourselves and equipment on one side, working our passage across to the other side.

(2) What do we need to achieve it?

We again have our list of gear required at the beginning of the chapter, but there are one or two things to explain. I have assumed that we are going to build across a distance of 20 to 25 feet and our crossing ropes need to be at least twice that length. The 2-2½-inch rope is for the footrail and the 1½-2-inch are for the handrails. The six lengths of 25-foot 1½-inch rope are for supports, and the four 50-foot long 2-inch ropes are for our ladders on the assumption that we are going up 40 feet. We shall also need a considerable number of ladder rungs, but we can probably make these on the site.

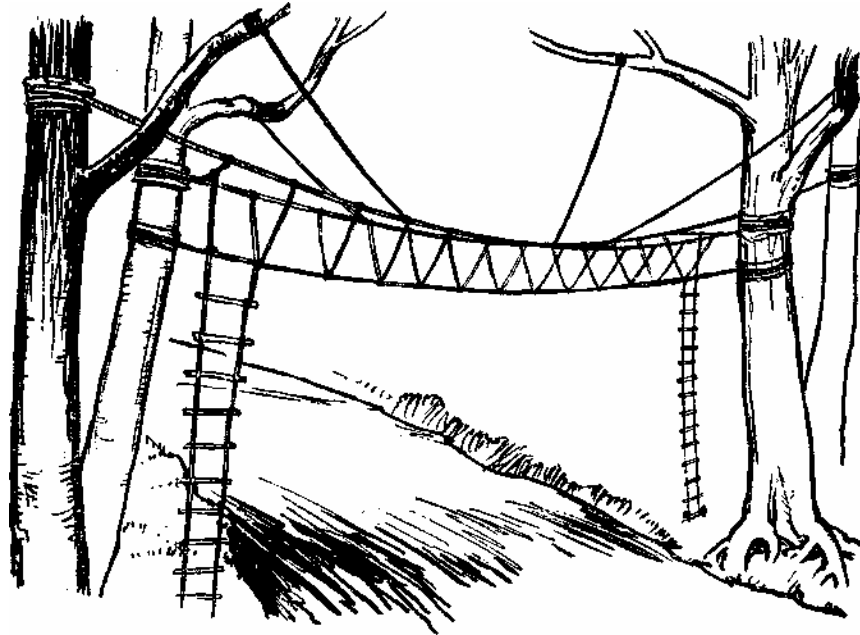

(3) Where are we going to do it?

This project can be constructed anywhere there are trees conveniently placed across a stream or a bridle path in a forest or across a ravine. I do want to ask you at the outset to be adventurous about this. The whole idea is that because we use no artificial means of tightening the ropes we build the bridge as high in the air as we can. We do not mind how much the bridge sags, but we really do get the experience of a safe crossing high above the ground.

(4) How long have we got?

This bridge is going to take one and a half hours of any Patrol's time. There is quite a lot to do and a lot of the work has to be done under difficult conditions.

(5) Who is going to do what?

That is for the Patrol Leader to decide, but he must allocate the jobs before they start.

(6) How are we going to do it?

The first job is to find some means of getting across to the other side of the stream. That means getting a rope across. It is a bit hazardous, but well worth trying the South American Indian bollass. This really amounts to three ropes about 3 feet long joined together at the centre, with a weight at the end of each rope. When thrown into a tree there is a very fair chance that it will wrap itself round a branch or a series of branches and make a reasonably secure hold. Now it may let you down; it may not hold firm at the first shot, so please don't try 50 feet above the ground. Try it very much lower so that if it does loosen the

Scout using it has not far to fall. A bollass fixed to the end of 1½ – 2-inch rope, thrown into a tree on the opposite side of the stream will enable an active Scout to get across hand over hand. This incidentally makes the quickest and most simple bridge there is. To throw a rope 25 feet – a rope that is strong enough to support a Scout – is going to take a bit of practice, and when you start building the bridge is no time to start to practise. Here is an activity to try out at a Troop Meeting, on a hike, or at home in the garden.

Of course, once you have a Scout at the other side of the stream he can make the rope really secure and another Scout can cross, or, he can begin, using a continuous line, to draw over the necessary gear.

This project obviously involves a deal of tree climbing. For making the rope ladders use the lever hitch to support the rungs as it is much more secure than when clove hitches are used and, of course, the supporting rungs can be fixed to the footrail and handrails. Remember that I did say, and I repeat it here, fix the sacking with sisal, do not try to fix it with your main rope. We are going to need a lot of sacking for this job.

Let us assume that on our starting side we have made the main bridge on the ground and it is ready to be hoisted. We need for this at least two Scouts, and preferably three if there is room on the tree for them; one on each handrail and one on the footrail. The ladder at this stage will not be in place, although it may be in use temporarily fixed to one of the branches. Haul the bridge up slowly, pulling the same amount on each rope and keeping it out of the water. Make it secure with a round turn and two half hitches or a fisherman's bend, and then throw to the man on the far bank a light line. If you just drag the bridge through the water you are going to make it very unpleasant to use and possibly you are going to damage it, but if the light line is thrown over a branch of the tree fairly high the Scout can use it as a lever and drag the bridge across without it touching the water. Then it becomes merely a matter of making fast, getting everything as tight as possible and making sure that the knots are really secure and that the bridge is balanced. It is very important in this type of bridge that whatever sag there is should be approximately equal between the handrails and the footrail. If the footrail sags more than the handrails they will go out of reach of the person walking across, a very uncomfortable situation for any but a trained tightrope walker.

So to the rope ladders. Make sure these are secured at the base as well as at the top.

This is not a difficult bridge; there are no fancy knots or lashings, but it is a considerable test of Patrol organisation. A great deal can go wrong, but carried out carefully and with sufficient time it can be a very sound job and a really exhilarating bridge to use. Incidentally, to those of you who collect butterflies, going up as high as this bridge is the only way I have found of seeing a Purple Emperor out of a glass case, and this is another reason for choosing oak trees.

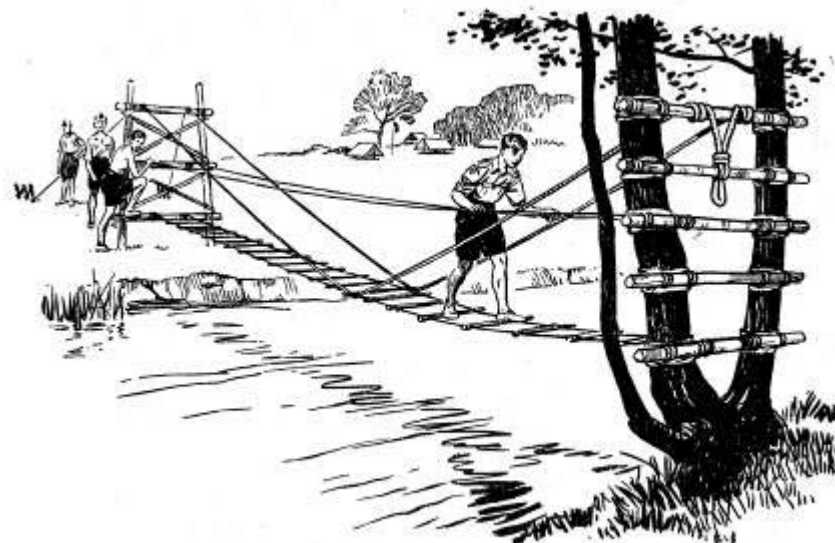

Ladder Bridge to Tree.

Chapter XVII

PROJECT NO, 12:

LADDER BRIDGE TO TREE

GEAR REQUIRED

Ropes:

- Two 3-inch more than width of stream for footway.
- Two 2-inch more than width of stream for supports.
- Two 1-inch more than width of stream for handrail.
- Two 1-inch 30-foot guy ropes.

Spars :

- Two 12-foot.
- Four 10-foot lighter spars.
- Eight 8-foot.

Pickets:

Six.

Lashings:

- Ten 20-foot.
- Sixteen 15-foot.
- Four 10-foot.

Oddments:

- Sacking for tree.
- Maul.
- Light poles for foot-treads (one every 2 feet of width).

NOW we are beginning to get a bit elaborate. There isn't very much to say about this, but there is a tremendous amount to do. This is a two and a half hour job for any Patrol, but it is a grand bridge when it is finished. First, of course, find your tree, or two trees will do rather better – two trees where you can lash on your cross-stays to give really good support. You don't perhaps need to lash quite as many as the artist has shown – some of them seem to be just decorative, but nonetheless you have to lash on at least three;

one at the bottom, one at the top and another one to finish off your handrail rope. This is really a type of suspension bridge. It works from a fixed tree to a movable trestle, and the strain is taken up by the pickets you can just see in the picture. For tightening, a Spanish windlass or block and tackle, whichever you prefer, but you must have something. The trestle needs to be a good solid stout job. The artist has shown a double trestle. There is a lot to be said for that as it allows us to use shorter and lighter poles for our diagonal braces which is a good idea. Notice how the bridge comes right back on one side. You can't move the trees back, though obviously it would be better if they were farther back. But the trestle is right back so that it is easy to get on to the bridge. None of this groping through the mass of ropes and through the trestles. You just step on sideways, ducking under the ropes rather like entering a boxing ring, and then you are on the footway, which is our old friend the ladder. Remember, rungs not too far apart. The handrails just above waist height. The artist shows them a little below, but that is because the fellow is leaning on them and that pushes them down to just where they ought to be.

Then note those two long supporting ropes carrying the main weight of the ladder. They are necessary if you are going to have a secure job. You might get away without them, but it could be very risky.

Chapter XVIII

PROJECT NO. 13: THE LADDER BRIDGE

GEAR REQUIRED

Ropes :

Two 3-inch twice width of stream
for footway.

Two 2-inch twice width of stream
for supports.

Two 1-inch twice width of stream
for handrails.

One 2-inch 30-foot for tackle.

Four 1-inch 30-foot guy lines.

Pickets:

Ten.

Lashings:

Eighteen 15-foot.

Four 10-foot.

Spars:

Four 12-foot.

Four 10-foot.

Four 8-foot.

Blocks:

1 double.

1 single.

Oddments:

Maul.

Light poles or staves for
treads (one to 2-foot
of width).

HIS, I think, is one of the most attractive and most stable bridges that I know, providing, of course, that it is built properly. It's a job for two Patrols at least – three if you have them available. It's rather too much for just one Patrol.

Our list of gear we have seen. We are going to survey our site as usual and let me remind you that one of the first jobs we do is to measure the width of the stream and allow a good yard each side before we begin to make the roadway. Having done that, it is just a matter of going to work, making very sure that we get our measurements right.

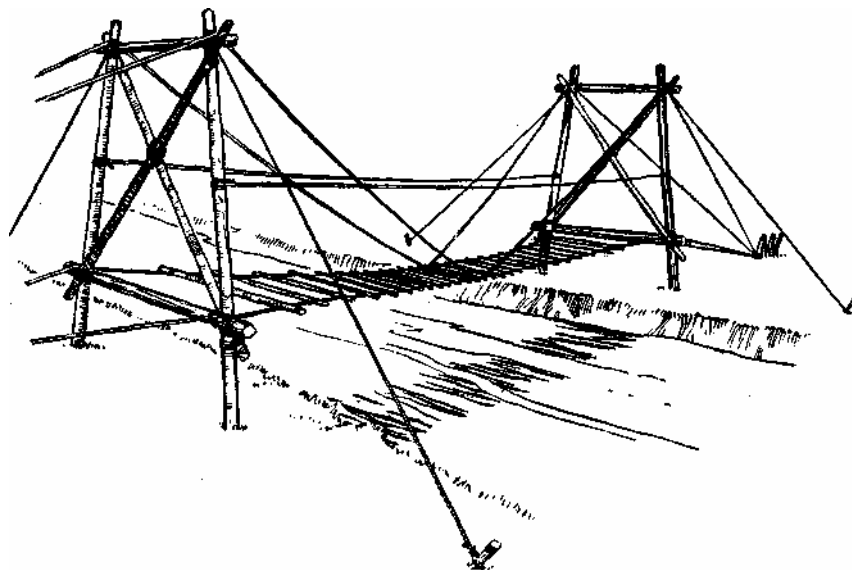

(1) How long will this one take?

Well, this is two hours of anyone's time, but it's worth it, because it can be made so well, this bridge, that it is almost permanent – as far as anything you make with wood and rope can well be.

The method of dividing up is fairly obvious. One Patrol on each trestle and one on the roadway and then combining to get the whole thing erected.

(2) How are we going to do it?

First, I repeat, measure the stream. Second, agree between the two Patrols the exact size of the trestles in all details. I do stress that *in all details*, so that when they go up they really are a twin pair, and not just two self-willed independent things that will have nothing to do with each other and won't support our roadway satisfactorily.

The roadway? Well we have made one before, so there is nothing to say about it except to remind you to use that lever hitch. Don't let the spaces between the rungs of the roadway be too great because if they are it can be difficult and almost dangerous to cross.

Notice that the artist has shown at least the first rung over the bank and not over the water. Note the proportions of the trestles: note the pickets: note how the ropes are taken, using the trestles, on to the picket. On the near bank, of course, you can have some tightening apparatus, a block and tackle or Spanish windlass, whichever you prefer, whichever is available: it doesn't matter much which.

Now the snags. Snag number one we have dealt with. If the trestles are uneven, that is, if they are not an exact pair, the whole thing is impossible and really highly improbable.

The second snag is uneven tension upon the two sides of the roadway. If, for example, the near side, the nearest side of the picture, is a bit slack and the other side is tighter, as soon as anybody treads on the roadway it is going to tilt and he is going to have an awful job to maintain his balance. So that means we must have exactly the same length of rope, they

must be brought over the trestles an equal distance apart and they must be brought back on the picket and tightening apparatus exactly together.

Then notice the guys – very vital in a bridge of this sort. I think what the artist has shown is all we shall need for this particular item. Notice the handrail. There is no need to tighten this because it shouldn't get loose, just make it hand-tight on to the trestles, and it will help to keep the trestles straight. The refinements as the artist shows us can well be the extra suspension rope, but it is not essential so don't feel bound to put it on; in fact try it without at the start.

Chapter XIX

PROJECT NO. 14: SUSPENSION BRIDGE

GEAR REQUIRED

Ropes:

Two 3-inch more than width.
Two 2-inch more than width.
Two 1-inch three times width for
supports or a number of lengths.

Spars:

Four 12-foot to 15-foot.
Eight 8-foot.

Pickets:

Ten.

Lashings:

Eighteen 15-foot.
Four 10-foot.

Blocks:

One double.
One single.

Oddments;

Maul.
Light poles and staves for
treads (one to every
2-foot of width).

HERE we have something very similar and yet really rather different from the bridge you saw in the last chapter. It is different in this regard, that we are relying really on rather a different method of supporting our roadway. Here all the weight is going to be taken by the handrails and by the upper part of the trestles, and that is why those trestles are supported higher up than they were in the previous drawings, and are made in rather a different pattern. One advantage is that access to the bridge is very much easier.

All that I have said in the last chapter applies here with those additions. The tightening will be on the handrails and not on the footway which is merely fixed to each trestle and supported, as you see, by continuous quite thin rope arranged carefully and equally. This, incidentally, is the main snag about this bridge – getting the strings between the handrail and the footway exactly equal on each side of the bridge. Just what degree of curve you get on the bridge – well, that doesn't really matter very much, but you see the higher you get your trestles the greater the curve possible and the more freedom you can allow for rafts, boats, swimmers to pass under your bridge – in fact, that is one of the main purposes of this project, and the additional one that this bridge requires very much patience – more perhaps than anything we

have done so far, and – I don't know how you feel about it – but I think it is an artistic job ; it really is a beautifully proportioned thing. Something we can look at, photograph, and be very proud that we have had a share in the making.

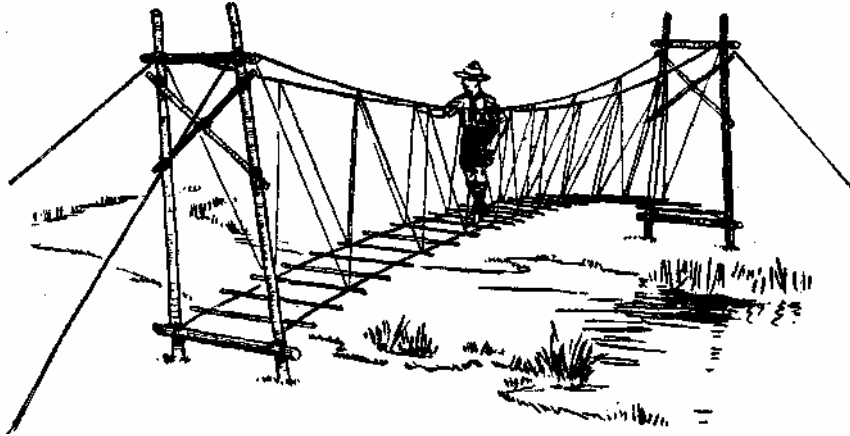

Maybe I have put this one a little too early in the book. I am inclined to think I have, but I will leave you to find that out with your Scouts yourselves. But don't duck this one; do try it, because if you can only get it right it is a bridge that will give you as much satisfaction as anything that we have talked about so far.

I ought to add one practical point to this bridge and the previous one. It may not be necessary to have two diagonal braces on the trestles. Remember every time you add a brace you are strengthening it but you are also adding weight, and that is a thing to avoid as much as possible.

Chapter XX

PROJECT NO. 15: LIGHT POLE BRIDGE

GEAR REQUIRED

Spars:

Eighteen 6-foot stout.
Six 5-foot light.
Twelve 7-foot light.
Twelve 6-foot light.

Lashings:

Twenty-four 10-foot.
Sixty cod-line.

Oddments:

Planking to bridge width.

Gear is for a 'six bay' bridge.
For any extra bays add one sixth
of each item.

HERE we have something rather different from anything we have tried before. There are all sorts of snags about this one, but what a lot of fun there can be in getting it right. I don't really think there is very much to say about it.

(1) What have we to do?

To build trestles and join them end to end crossing the stream from one side to the other. Yes, that's what we've got to do, but when we come to the "How" it may not sound quite so simple.

(2) What do we need to achieve it?

I would stress the words in the title "Light Poles". You can build a bridge like this out of Scout staves and nothing else, but you may have to use a certain amount of heavier timber, but do try to keep it all on the light side. The structure is such that it doesn't need heavy wood. Heavy wood that has to be used in water takes a good deal of handling.

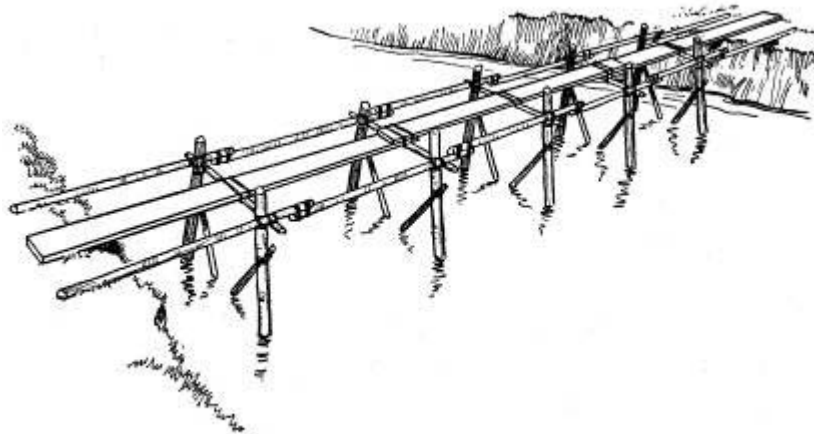

Light Pole Bridge.

(3) Where are we going to do it?

To start with, in a fairly simple place. Quite a shallow stream, perhaps not more than a foot or eighteen inches deep, and gradually as we become proficient at this sort of bridge we are going to adventure into deeper and dirtier and more dangerous waters. But just one thing, don't try to build this bridge in a swiftly flowing stream. It is a good guiding rule that if you have a swiftly flowing stream you bridge over it, and in a stream that moves only slowly or not at all bridge through it. We have met the same problem already, of course, in the Scout Transporter.

(4) How long have we got?

Oh, you need a lot of time if you are going to get this one right. I'm not even going to venture to suggest how long, except to say this is a whole morning or a whole afternoon of any Patrol's time, and what a memorable morning or afternoon it can be!

(5) Who is going to do what?

This job divides up very well. You need trestles, but you don't need them all at once. They can be being made on the bank, and as required they can be pushed out into the stream, because this is a bridge where we are always using the parts we have built to act as a base to build farther forward, so the Patrol ought to be divided up so that everyone gets a chance to make a trestle, and everybody gets a shot at erecting a trestle, so that the work and the fun and the experience are shared really equally.

(6) How are we going to do it?

In addition to our list of gear, we need to know the depth of the stream at every point where we are going to put the trestles and we need to know the consistency of the bottom of the stream.

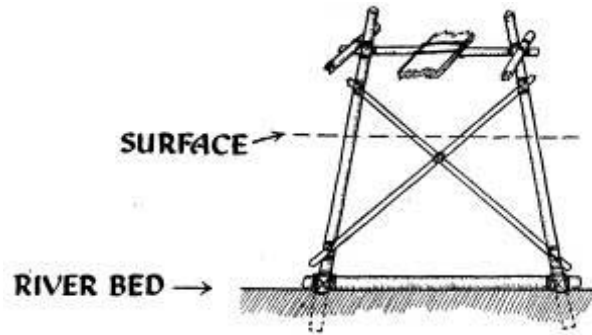

The first thing you have to do is to get that first sounding, to know exactly where your first trestle is going and then make it exactly the right height you want. By and large, of course, the top of your trestle needs to be on a level with the bank. There is no point in going uphill, stupid to go downhill. Try to get it level. Then build your trestle. Build it as the artist has shown you and notice the proportions of that trestle, six units at the base, five at the top. That is about right for this sort of job. Transom and ledger fixed on with square lashings. Remember the starting clove hitch (and this applies to all lashings) always ought to be against the mass of the strain. In other words, at the top of our trestle our clove hitches will be under our transom, that is, nearest to the base because the strain is a downward one – we tread on the bridge so we put that clove hitch in where it will do the most work. But with our ledger, that is at the base of our trestle, put the clove hitch on top because there the pressure is upwards, the bed of the river pressing against our ledger and so we put our clove hitch to work against that pressure.

Then our two diagonal braces. Fix with square lashings where they meet the main part of the trestle, and fix with diagonal lashings where they cross each other. Incidentally, the artist has shown them wrongly, but I'll leave you to decide where he has gone wrong.

When we have made that trestle we have to launch it, we have to get it upright, we've to secure it to the bank with staves or light poles so that it really stays upright, we fix to the bank, or half log or whatever is handy and we are ready to launch our next trestle. *But* the river will be a little deeper, our trestle will need to be a little bigger, and if we are going to keep that level roadway as the artist has shown us, we have to be very exact in our measuring. So we go on. First getting deeper – bigger trestles, then shallowing out when we come nearer to the other side. It needs a deal of very careful measuring.

This particular bridge offers another possibility. It is obviously a sound idea as a jetty jutting out from the side of a stream or lake. Somewhere for a boat or raft to be moored to. You can get it into quite deep water, 6 feet, 8 feet, even 10 feet deep if you have enough poles and if you are prepared to have a go at it, but you will find the deeper the water the harder it is to anchor your trestles. The bottoms will tend to float upwards, being made of wood they will naturally tend to rise. Then you will have to fix weights to them, bricks or stones, and here is a chance for the expert swimmers and life savers to dive down to the feet of the trestle and practise a little knotting under the water. It is a grand experience. I have seen it done and how worth while it is.

Yes, this particular project has all kinds of possibilities. I hope you will thoroughly enjoy trying them out.

Chapter XXI

**PROJECT NO. 16:
THE COUNTERWEIGHT BRIDGE**

GEAR REQUIRED

Ropes:

Two 1-inch 20-foot for handrails.
One 2-inch 15-foot for lifting.
Two 1-inch 40-foot for guys.

Spars:

Four 12-foot to 15-foot.
One 15-foot to 20-foot (lighter
than above).
One 6-foot stout.
Two 6-foot to 7-foot.
Seven 4-foot.
Twelve 5-foot light.

Pickets:

Eight.

Lashings:

Seventeen 15-foot.
Three 20-foot.
Twenty to twenty-four 6-foot
light lashings for treads.

Oddments:

One log about 8 feet long
and 2 feet 6 inches in
diameter.
One log 2 feet long, 2 feet
diameter.
One sack and some bricks or
other weight.
Maul.
Spade.

HERE we have a project which involves a rather new principle but is really very simple and effective when it is properly made. First to our questions.

(1) What have we to do?

To make a bridge capable of spanning a narrow stream, capable also of being raised above bank and stream level to allow a boat to pass by.

(2) What do we need to achieve it?

Well, our list of gear as always. I've said that a lot, I know, but I can't say it too often because unless we really are able to decide exactly what we need, what we have got and what we have to provide in addition to what we have, then our pioneering will remain a muddle. It may be good fun but we shan't achieve any success, so perhaps in this chapter it is time to remind you to look at your gear before you touch it. Make sure you have what you want before you start to use it. When you are satisfied then, and only then, begin the work of construction.

(3) Where are we going to do it?

Across a stream for preference. Perhaps we will start on a ditch, a dyke, an old tank trap, something not too wide. I would suggest about 10 feet in width. Somewhere where the two banks are approximately the same height. It is a very difficult bridge to manoeuvre if you have a very great difference of heights between one bank and another, and also our banks need to be reasonably firm, especially the far one where our bridge is going to rest.

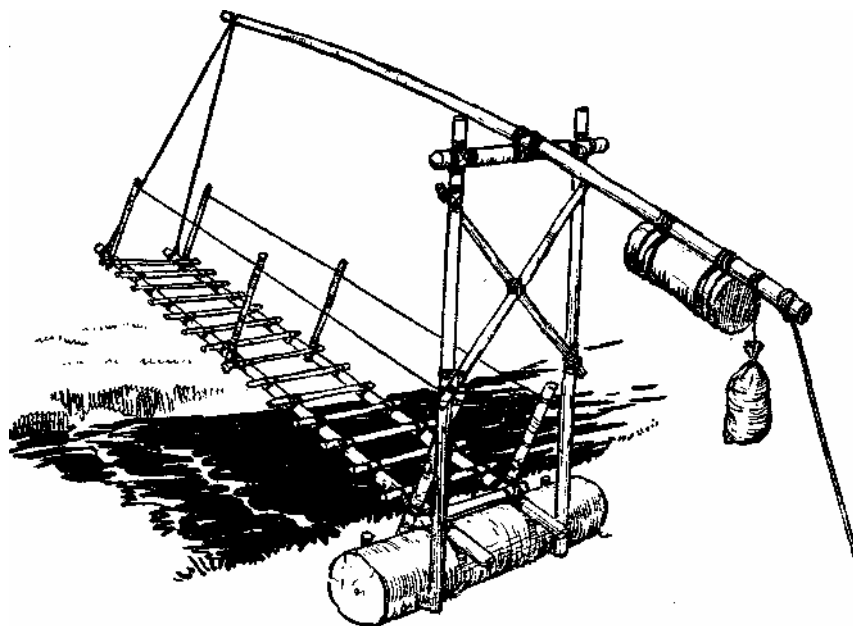

(4) How long have we got?

Well, this is all of two hours. Not a great deal of work in it, but there is a great deal of adjustment required, and adjustment takes time. Two hours' work for a Patrol: an hour's work, though, for two Patrols. I often wonder if we are not wrong in just thinking in terms of Patrols and Troops. I know those are the main divisions of our Scouting, but the combination of a couple of Patrols, particularly in pioneering, has a very great deal to be said for it.

(5) Who is going to do what?

Let's assume there are two Patrols on this job. One Patrol will make the bridge part, that is the ladder and the supports and handrails. The other Patrol meanwhile will produce the supporting trestle and then the two Patrol Leaders will get together to make the beam and the counterweight while their Scouts take a rest and admire their handiwork. I think that is a fair and a sensible division of labour.

(6) How are we going to do it?

First get the width of the stream. I have said that very often too, but so many times is it forgotten. What a lot of heartburning there is when after two hours' solid work we find we are 2 inches short of the far bank. Two inches short – you might just as well be 2 feet or 2 yards short. It just won't work. So measure your stream. Throw a line over and get the exact measurement when you pull the line back over to your own side of the stream.

Here, incidentally, is a bridge where we can all start on the same side. There is no need for anyone to go across until the bridge is finished. If you haven't got a stream and you want to practise near your Troop headquarters, well, mark out a stream with two lengths of sisal, and stick to one side and work from it.

Now the ladder, I think, doesn't call for much comment. A fair amount of lashing. Don't get the ladder too wide. You may later be a bit ambitious and make it wide enough to take a trek cart, but start by concentrating on getting yourselves across. Rungs not too far apart, 2 feet to 2 feet six, not more than that. Note the rungs are on top of the supporting spars, fixed on with square lashings. I've seen ladders built with the rungs on the other side, which is just

stupid, because it means the rope is doing all the work instead of using that gallant combination of ropes and spars. The rungs on top of the ladder.

Handrails – fix them at a convenient height at about waist level and fix them as the drawing illustrates, with a few uprights. Obviously the longer the bridge the more uprights we shall need.

Now the trestles. You really have to get those top poles into the ground. That is a bit of a problem. Dig them in a bit, hit them in with a maul the rest of the way. The trouble is how do you get up there to use a maul? Well, that is up to you, I think you will find a way; remember the High Hoist?

Notice that we have put the braces high up. There is a reason for this. The reason is very simple: to enable us to get on and off our bridge without having to clamber through a lot of poles. Remember what I said about having good easy access. You don't want an obstacle race. This isn't an obstacle, it is a working bridge.

You need a log – a fair-sized log. In fact, I'd almost say the bigger the better. Roll it into place. Fix it with pickets on one side and the main spars of our supporting trestle on the other side.

Then those back handrail supports. You want to be clear about this: they are a little bit longer than the others on the bridge, that is they protrude below the ladder, but not so far that there isn't room for them to move, because the whole principle of this bridge is that when you pull on the balance you can lift up that ladder as high as you want it and nothing can prevent it coming up. The exact length of those spars you must get by practice. Get them so that they grip and so that they don't impede.

Lastly, we come to the counterweight part. You may wonder why we have two weights. There is really a very simple explanation. You have your log, that is the fixed weight, then you have your bag (of sand for preference, or any sort of earth or even bricks would do), which is your adjustable weight. You can't be sure just how much weight you are going to need until the bridge is finally up. Then it's too late to fix a heavier or a lighter log on: it is a simple matter to adjust the amount of sand in the bag. In fact, if you have an old sack with the corner broken you can keep that tied up, tying the top as well of course, and it is very easy to empty out a little sand to get the weight exactly right.

The lashing where the beam goes over the main trestle presents something of a problem. The one we have used, and I think it has been successful, has been a square lashing with no Trapping turns, and put on sufficiently tightly to hold the beam in place but not so tightly that it can't move up and down.

There it is then. I think you will find this particular bridge is a great delight. Your aim should be to achieve one that can be moved almost at the touch of a hand. You shouldn't have to pull it up. It should be so perfectly balanced that just by leaning gently on the guiding ropes it will come up and when you release your hold it will stay in whatever position you leave it. You may not get it as perfect as that the first time, but it can be done.

Lastly, a word about the far side. It is a good thing to have the roadway of any bridge really level, so if you can roll another log into place after your first man is across the bridge so that the roadway can rest on a log on the far side, then you will have a bridge that you will be really proud of – one too that has something, I hope, of originality about it. I hope you will enjoy it. I did the first time I tried it and I've admired it every time I've seen it made.

One afterthought: the roadway is greatly strengthened by adding Diagonal Braces, one to each six foot length. If timber is available use touching spars for actual roadway. This applies to all similar constructions.

Chapter XXII

PROJECT NO. 17: THE DRAWBRIDGE

GEAR REQUIRED

Ropes:

Two 2-inch 30-foot.
Two 1-inch 20-foot (hawsers).
Four 1-inch 40-foot guys.

Spars:

Four 15-foot to 20-foot.
Two 12-foot to 15-foot.
Three 10-foot.
Seven 6-foot.

Pickets:

Nine.

Lashings:

Eighteen 15-foot.
Twenty-five to thirty 10-foot
light for treads.

Blocks:

Two single sheave.

Oddments:

One log about 8-feet long.
Maul.
Twelve to fifteen light poles
for treads (one per 12
inches of width).

THIS drawbridge is still well within the capacity of a Patrol of Scouts, but it will require two to two and a half hours if a thorough job is to be made.

Let us first of all look at our list of gear. I know it is rather a lot.

The Patrol Leader is going to be in some difficulty here because the average Patrol will not contain sufficient Scouts to do the job in sections simultaneously and assuming a Patrol of six I would put four Scouts on the main roadway as a start. Now this is a fair test of patience and thoroughness. There are about fifty square lashings required and it is important that the last should be as good as the first and that the first should be very good. Of course, for speed one could substitute a ladder for the made-up roadway, but I hope your Patrols will tackle the job as illustrated. A point of some importance is to make sure that the roadway is built the right way up. All too often I see Scouts trusting to the strength of a lashing instead of trusting to the strength of a lashing plus the supporting spar. The actual length of the roadway is going to be determined by the distance to be spanned and it may be that your spars are not long enough. Well, it is cumbersome but by no means impossible to lash two spars together to give the required length, but, when you have to do this, try to arrange that the two lashings are not opposite to each other. Obviously where the spars meet is going to be the weakest part of the structure and if you can spread that weakness over the length of the roadway it is far better than confining it to a central point.

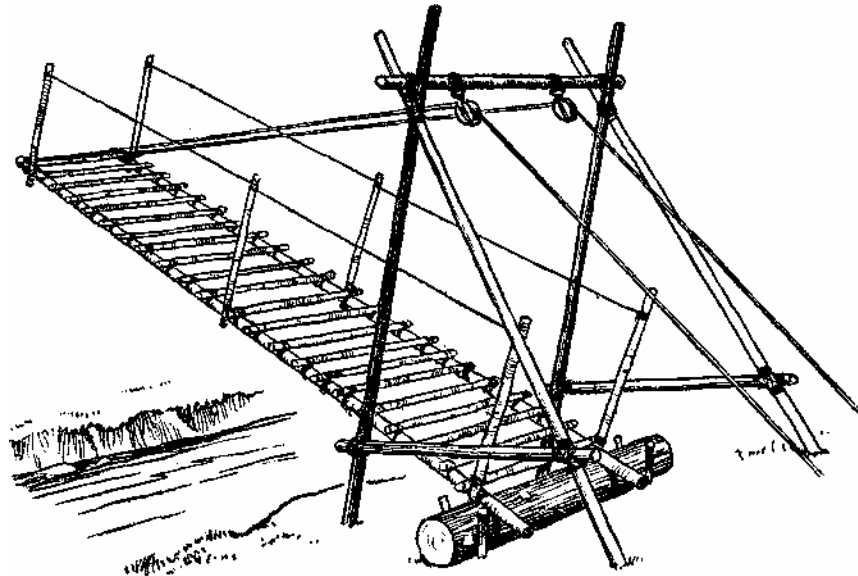

Our first job, then, is to make the roadway and fix on the uprights. There is much to be said for having more uprights than the artist has shown. The next job will be to build two sheer legs. Divide the Patrol into two parts with the Patrol Leader making quite sure that the trestles are going to be twins.

It is very important in a thing of this sort that the two parts should be exactly the same, otherwise the drawbridge will be quite unmanageable. Use sheer lashings at the top and square lashings at the base.

The next job will be to get the log into position and to drive in pickets to hold it firmly. Then bring the sheer legs into position and secure them by easing the bases into the ground for a depth of about 9 inches. It may be necessary to take a couple of guys from each and, certainly if you are building on ground where you cannot dig, it will be necessary to guy them.

The next job, which has probably been going on alongside the other, is to fix the two pulley blocks to the crossbar. Now this is where Scouts usually slip up. Don't fix the bar first and then the pulley blocks; it is much more difficult and there is no point in it. Always make a job as comfortable as possible because one does it better that way. Fix the pulley blocks by two or three turns round the bar and mouse the hooks. Run the ropes through the blocks and whilst the roadway is still on land fix the ends of the ropes to the end of the roadway. This will enable you to launch the roadway, using the structures you have built to help you to do it, the roadway being launched between the sheer legs and controlled by the ropes.

This really is all there is to it, but here are a few final points. Obviously the higher you make the sheer legs the higher your bridge can be lifted. It may be necessary to secure some reasonable landing-point on the other side – another log or a few rocks so that the roadway when in place is level.

Diagonal braces to the roadway are an improvement.

Chapter XXIII

PROJECT NO, 18: THE SWINGING DRAWBRIDGE

GEAR REQUIRED

Ropes:

One 2-inch 30-foot tackle for hoist.
Two 15-foot 1-inch handrails.
One 1-inch 40-foot guy.
Two 1-inch 30-foot guide lines.
One 1-inch 20-foot Block hoist.

Spars:

Two 18-foot to 20-foot.
One 15-foot stout.
Two 12-foot to 15-foot.
One 5-foot to 6-foot stout.
Six 5-foot.

Pickets :

Eleven.

Lashings:

Twenty-five to thirty light
10-foot.
Nine 10-foot.
One 30-foot.

Blocks:

One double.
Two single.

Oddments:

One log about 6 feet long.
Maul.
Ten to twelve light poles for
treads.

HERE we have something that does almost everything known to pioneering except talk. No doubt your Scouts will supply the deficiency.

(1) What have we to do?

The purpose here is to produce a bridge (or a jetty perhaps is more accurate) that can be lifted vertically out of the way and to some extent can be pulled from side to side so that clear passage can be afforded to a raft or other craft. In other words, there are two distinct movements.

(2) What do we need to achieve it?

I don't think there is very much to say here. Our list of gear we have considered. May I just remind you that the main work in this has to be done by that upright pole, as in all derricks, and that pole needs to be more substantial than most we shall use in pioneering, a pole that is thoroughly reliable, because if it snaps when the bridge is in use it could be rather nasty, so pay special attention to the choice of that pole.

(3) Where are we going to do it?

Well, I don't think that matters very much. Perhaps we might experiment over something very narrow, but ultimately I hope we will use it on the side of a lake or reservoir where it can have a real use as a movable pier or jetty; somewhere we can land from our raft or boat and where we can get it out of the way when it is not in use.

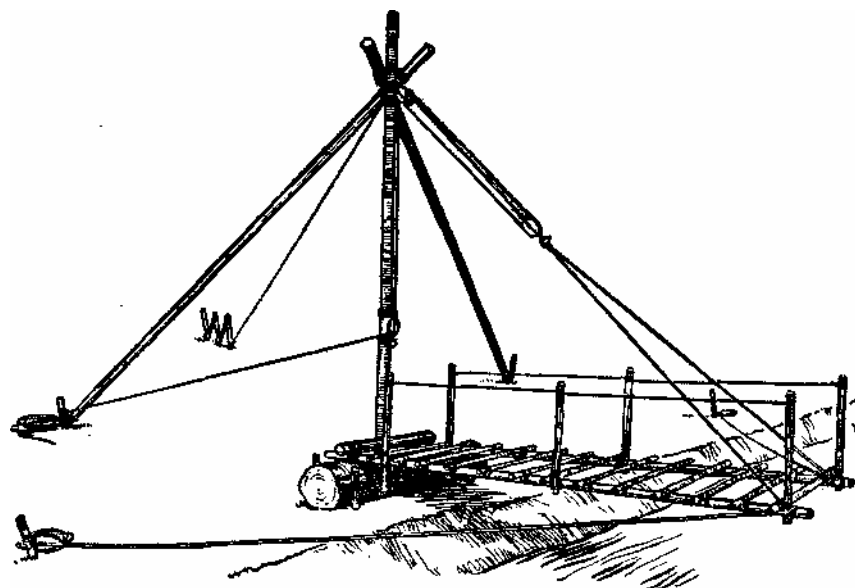

(4) How long will it take?

It shouldn't take very long really. An hour and a half ought to be enough for this one. There isn't a lot of work, it is just a question of doing what is required sensibly and accurately.

(5) Who is going to do what?

I think this is really a job for one Patrol, though two could be used, but one ought to be able to manage. Half the Patrol makes the derrick part, the other half making the roadway part and combining together to put the log in place and get the two parts assembled.

(6) How are we going to do it?

There aren't really very many snags, except in regard to movement. The up and down movement – well that doesn't call for very much comment, except that you ought to remember that it is very easy to become chock-a-block. As the artist has drawn it we should become chock-a-block, that is the two blocks coming together so that we have not enough room to lift up the roadway. We should become chock-a-block much sooner than we really want to, so I'd lengthen out my block and tackle to roughly twice the length shown.

Note the pickets and the supporting-trestle to the main spar. They are lashed down to the ground – that is very vital.

Then note the other movement. Our first upright in the handrail in the drawing is shown too near the block. There wouldn't be enough room for them to move from side to side. They ought to be about two rungs farther forward. Given that, then it is possible to adjust a loose lashing to the back rung of the ladder, over the top of the log and round the back of the main spar – it is possible then to get that sideways movement.

You will notice the guiding ropes which will enable you to do that. They, incidentally, must be long enough to pull in and also to let out when you pull in the opposite direction.

I think you will enjoy making this one. Although there is no drawing I am going to suggest that after you have done this particular method, the next advance is to try to use a cartwheel and either to mount the cartwheel on the log or scrap the log altogether and mount the bridge on the wheel; then I think you really will have achieved something original,

something practical, something that embraces a great many of the pioneering principles that we have practised together.

Chapter XXIV
PROJECT NO. 19:
THE SINGLE LOCK BRIDGE

GEAR REQUIRED

Ropes:

Four 1-inch 10-foot handrails.
Two 2-inch 50-foot.

Spars:

Twelve 12-foot.
Four 8-foot.
Four 5-foot.

Lashings:

Forty to fifty 10-foot light.
Thirty 15-foot.
Six 10-foot.

Pickets:

Twenty-two.

Blocks:

Two single sheave.

Oddments:

Two logs 6 feet to 8 feet long.
Maul.
Twenty to twenty-five light poles for treads and hand-rail supports.

HERE we are getting on to something very elaborate, something that is perhaps going to take longer than anything else we have yet had to do.

(1) What are we going to do?

The idea is to erect two movable trestles, drawbridges really, which when they meet in mid-stream will lock together and we shall then have a roadway over which we can pass without difficulty. Well, it is easy enough to write, it is easy enough to say, but it is by no means easy to do in practice.

(2) What do we need?

Our list of gear we have, I hope, read and digested. There is nothing very elaborate needed, but rather a lot of everything.

(3) Where are we going to do it?

Well, I think this is a bridge that we try essentially for the first time either over a very narrow stream – almost I am inclined to say a ditch – or else over dry land. I think in learning to build this bridge it is necessary to be able to ignore the stream, so that when we come to build actually over a stream we have had good previous experience. This is very much a project where we can't expect to get first-class results on the first occasion when we try it.

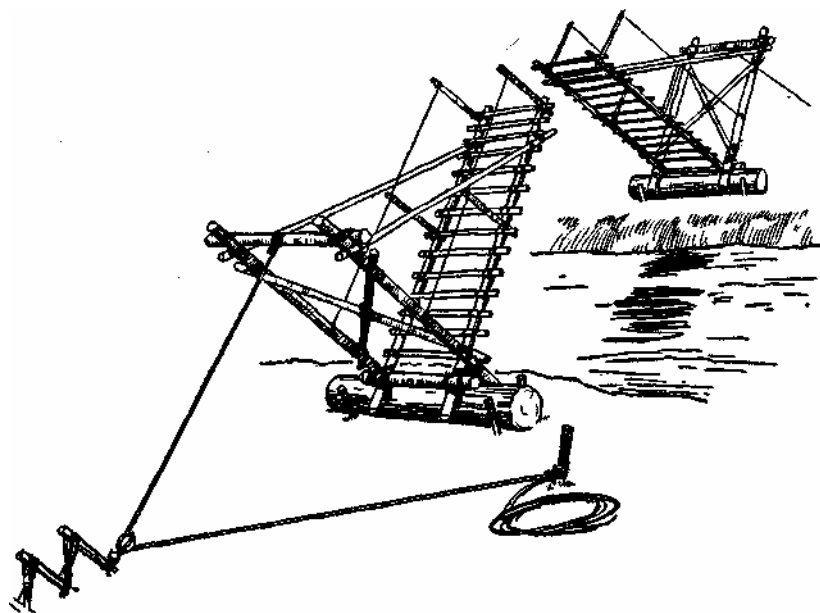

(4) How long have we got?

Quite a long time. I think this is a full day's work for two Patrols. It can be done in less time if we are experienced, but there is a great deal to do – that's obvious from the drawing ; a great deal of adjustment to be made and some of the work can become a little tedious. I think there is a lot to be said, for example in camp, for a couple of hours in the morning, break for lunch, and then a couple of hours in the afternoon or evening, to finish off.

(5) Who is going to do what?

Well, two Patrols doing identical jobs with P.L.s in charge on either side, and perhaps here ideally a Troop Leader supervising the whole arrangement. Or, even the Scoutmaster on this occasion, though I would really prefer the Troop Leader with the Scoutmaster standing by ready to test the finished apparatus, with pride and pleasure I hope, and at least not with too much disaster.

(6) How are we going to do it?

I think the drawing makes the whole situation quite obvious. Our first job as always, is to measure the stream, and then to agree on the exact point of disembarkation, that is the point where the two logs are to be fixed to the ground, and I think they ought to be fixed into position first. Get those right and then all ought to be reasonably plain sailing.

Then we divide the distance between the centre of the two logs, that is the width of the stream from log to log, and make sure that each Patrol is going to work to half that distance. In theory, of course, it is not at all difficult to make the two ladders the same size, in practice spars will quite probably vary a bit and adjustments have to be made.

Well, let's get the ladders set up fairly quickly. It shouldn't take too long, and again let me remind you – rungs on top of spars and not the reverse. Leave the handrails for the moment – they can be put on later.

Next the upright trestles. They must be pretty substantial; they need, on this occasion, to have a bit of weight to them because they are going to do quite a lot of the work of lifting the bridge. Perhaps I ought to make it clear that I regard this particular bridge as one which

we can open up and let a boat through if we want to; we don't try to make it a permanent fixture. It can be made that way, of course, and there are occasions when it is right to do so, but I think it will be more fun if it moves – that is, moves when we want it to, not when we are not expecting it to.

The trestles, then: I think on this occasion I should have them squarish and not quite like the trestles we have used in most other projects. You may find that you only need one diagonal brace on each trestle; anyway, it is as well to try it in that manner.

Having the trestles in place, the next thing is to fix them at right angles to the two ladders and this you can see has been done by adding two longish but lightish spars to complete a triangle between the uprights of the trestle and the bearer of the roadway. A triangle that does contain a right angle: that is very important.

Then as to the lifting mechanism: the artist has shown us just a single lifting block fixed to a pulley which ought to be fairly good, but it depends on the length of the roadway whether you need a single block or whether you need a two and one. I suggest that is a matter to please yourself about, but do notice and include the stakes where you can fix off your rope when the bridge is in position. It is no use just leaving it about, and it is not good pioneering to fasten a rope to itself. If you want to anchor it you ought to fasten it independently.

What else is there to say? The tendency of a bridge of this sort is that it will try to set itself crab fashion, that is, by wobbling about sideways instead of the nice, smooth, up-and-down movement which we desire. If it goes crabwise it probably means our lashings and structure are not secure enough, or perhaps that we have two uneven weights between one side and the other. If, for example, on the right-hand side of the roadway you have a spar that weighs appreciably more than the one on the left-hand side you will find the bridge will tend to pull to the right. So the choice of gear is important in building this particular bridge.

Well now, as to how you finally fix the bridge. If you have adjusted everything properly the two ends of the roadway ought to lock one into the other, but it is quite easy to secure that they do in any case, by having a loose spar which you lash on underneath the two rails when and where they meet. You will then have a stable bridge and something that will stand up to a lot of wear.

Finally, note how the artist has shown the bridge, with the logs, that is the supporting part, well back from the bank, again so that it is stable, and so that you can get on to the bridge and so that you can cross in comfort and security.

I said leave the handrails till later, and there are a lot of reasons for doing this, because they are apt to get in the way while we are constructing the job and they can very well be put in place afterwards; in fact, an adventurous Patrol might not even bother to have them at all – that I leave to your discretion and to the spirit of adventure in your own Scouts.

Just a word about the movement on the log. It may be necessary to take the turf away from under the log so that the log sits into the ground, as it were, and doesn't just rely on the¹ pickets. We don't want the log to roll; we want the business part of the bridge to roll on the log, so we do want the log to be secured quite fast. Another way, of course, would be to rope the log to the picket and you must see of course that the ends both of the roadway and the trestle are protruding sufficiently to grip the log, but not so much that they jam into the ground before you want them to. Ideally, when the bridge is in place the ends of the trestle will just rest on the ground to give the bridge added security.

Well, here is something that I can recommend to you – something that is worth the trouble – something that I think your Scouts will benefit from trying. It is not a bad thing to try this out in very much lighter material, even indoors on a wet evening. It can be built with Scout staves, not really for use but for demonstration. That I think is worth doing.

Chapter XXV
PROJECT NO. 20:
THE SWING BRIDGE

GEAR REQUIRED

Ropes:

Two 1-inch 15-foot handrails.
Two 1-inch 30-foot guide ropes.
One 1-inch 30-foot guy.

Spars:

Two 12-foot to 15-foot.
One 10-foot to fit wheel.

Lashings:

Thirty light.
Four 15-foot.

Pickets:

Three.

Oddments:

Maul.
One cartwheel as large
as possible (sound
axle shaft).
Ten to twelve light
poles for treads and
handrail supports.

YOU will see from our list of gear that we have introduced rather a new feature, that is, an old cartwheel. And I do stress *old* because as long as it is reasonably sound it doesn't matter how old it is; it doesn't even matter what size it is, though broadly speaking the larger the better. You need the cartwheel and you need the axle. Not all of it, half of it really, otherwise you will have to make one on the spot which is a little difficult and takes time. I hope you will find a friendly farmer who will produce one for you. You may have to pay a few shillings for one, but it is well worth it for, as you will see in this book, we have a number of uses to which it can be put, and it is really difficult to find a substitute. In theory, of course, one could use a trek cart wheel. In practice, I don't think that is very desirable. Trek carts are too valuable these days; although in an emergency one might use such a thing, I think for the moment we will try to rely on the old wheel. It is surprising what a lot of them there are about in farmyards, and it is surprising how glad farmers are to get rid of some of their old lumber.

Well now, let us begin at the beginning with our Swing Bridge.

(1) What have we to do?

Fairly obvious from the drawing, I think. To build a ladder bridge, for that is what it is, that can be revolved through 180 degrees. Ninety degrees would be enough, but 180 is better. Make sure, first, that you have measured your stream, and then make sure your bridge will be free to run. I don't mean mechanically, we'll come to that later, but it will be free to run in

that there is no tree in the way, no rock, or rise in the bank that will make it impossible. All that is part of surveying the ground.

I think we can skip our next two questions because the answers are so obvious and so come to:

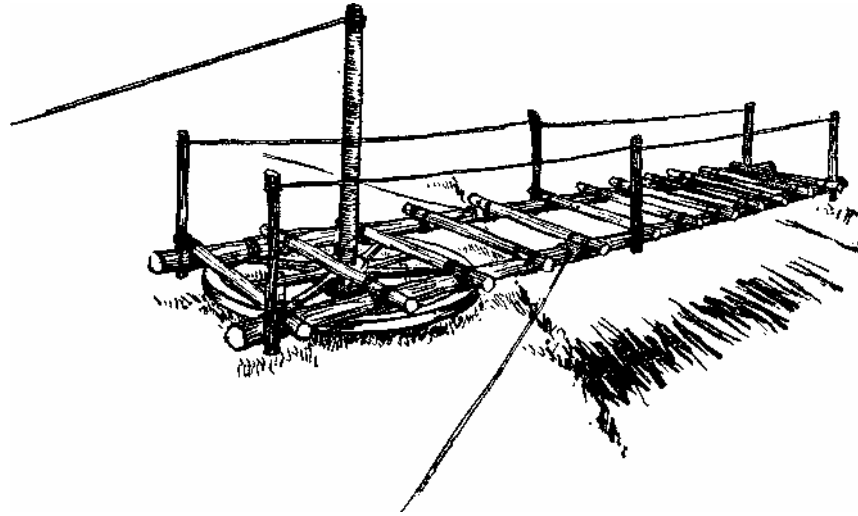

(2) How long have we got?

This takes rather longer than at first sight appears. An hour and a half to two hours, I think, on this one. There is not a lot to construct, but it is one of those projects that somehow needs quite a bit of adjusting. Still, all that we can come to as we go along.

(3) Who is going to do what?

This one doesn't divide up very easily. All the Patrol has to be in it all the time. Everyone can get a bit of lashing practice on the ladder part of the bridge. Once again let me remind you, rungs on top, bearers underneath. Let the lashings and the woodwork work together and not independently. And so we come inevitably to:

(4) How are we going to do it?

There is really nothing to say about the ladder part because that is quite simple and straightforward. One problem is in fixing it first to the wheel and then fixing the wheel to the ground in such a way that it will work. I am afraid we have to do a bit of digging here. I don't think there is any way of avoiding it. You must dig a hole and bury the axle of the wheel upright just where you want it, which as you will see from the sketch is just a little way back from the bank. Then we are ready to drop our wheel on to the axle, and on the top of the wheel – this isn't really necessary but is just for support – we are going to fix a sort of guide post. We've found in practice it helps to have that there. It stabilises the bridge a bit, but equally we have sometimes had good results without it there at all.

Then the problem is how are we going to lash the ladder part to the wheel so that the wheel will revolve. There is not much difficulty about the lashing. You've plenty of spokes to the wheel. Use of course simple square lashing, or diagonal if you prefer it, and there is much to be said for the latter on this occasion. Diagonal lashing four points on the wheel, having arranged your cross-pieces, that is, the rungs of your ladder where you want them; that ought to do the trick. But, this is the snag. Unless we have it really well balanced, that is, unless we've put our framework squarely on the wheel, we are going to get it tilting

sideways. I'll come back to the forward tilt in a minute. So we must get it really well balanced as it were on the east and west front. Once we have achieved that we are nearly there as far as we can ever hope to be. But, of course, we have far more weight on the business end of our ladder than we have on the other end. That will tend to tip the wheel over. There are two things we can do about that. The obvious one is to add weight to the rear end of the bridge, fixing lots of rock on to the wheel, but I think a neater, and in my experience a more satisfactory way, is to get some smooth stones and put them under the front rim of the wheel so that they act as sort of ball bearings, so the wheel will keep free from the ground, but it will be running on a ridge of stone. It is not difficult usually near a shallow stream to find something of this sort. Many cartwheels will have an iron rim which will help the wheel to run over the stones. It makes a bit of a noise but no more noise than a Patrol working on the job is likely to make anyway.

Well, that is how it can be done. That is how I have seen it done. Finally, I think the guide ropes the artist has shown are a little too far back on the structure. They ought to be just over half-way the distance of the width of the stream, then you will get the best pull with the least effort, which is always a good thing to aim at. Make sure the landing on the far bank is secure. Maybe you will need to put a log or some more stones for the end to rest on, to keep your bridge level. You don't want to cross a bridge downhill if you can avoid it.

This, perhaps in combination with a raft, is a very pretty piece of pioneering. The raft sails down with the tide, the bridge is swung out of the way and the raft passes, the bridge swings back into position and over go the Patrol to greet the raft, from which the others have by this time landed, or perhaps it has capsized downstream, who knows?

You should have a lot of fun with this one, and we shall be coming back to our cartwheel in later chapters.

Chapter XXVI

PROJECT NO. 21:

THE DOUBLE SWING OR THE ROUND BRIDGE

GEAR REQUIRED	
<i>Ropes:</i> Two 1-inch 30-foot guides. Two 1-inch 15-foot hand-rails.	<i>Lashings:</i> Thirty, light lashings. Four 15-foot.
<i>Spars:</i> Two 12-foot to 15-foot. One 6-foot to 8-foot centre to fit wheel.	<i>Oddments :</i> Cartwheel as large as possible. Ten to twelve light poles for treads and handrail supports. Maul.

THERE is very little to say about this project, because it follows quite naturally from the swing bridge that we dealt with in the last chapter. But there is a certain amount to say.

I don't think we need to go through all our questions because most of what I have said in the last chapter applies almost exactly here, but we need to consider first the exact situation in which we would want to build anything like this, and where it would be possible to build it.

Seen as the artist has drawn it, it all looks very simple, and given the right situation it can be simple, but the right situation is really this. Fairly level banks, as level as possible, shallow stream, a foot to 18 inches, or better still perhaps, a morass, where we want a bridge that can be thrown across quite easily and either turned out of the way to let something else pass who might want the stream, or in regard to a marsh, it might lead across the marsh to a camp site and we wanted, as it were, to shut the gate or pull up the drawbridge as soon as we were in camp. We should, of course, be able to achieve that rather desirable result with a structure of this nature.

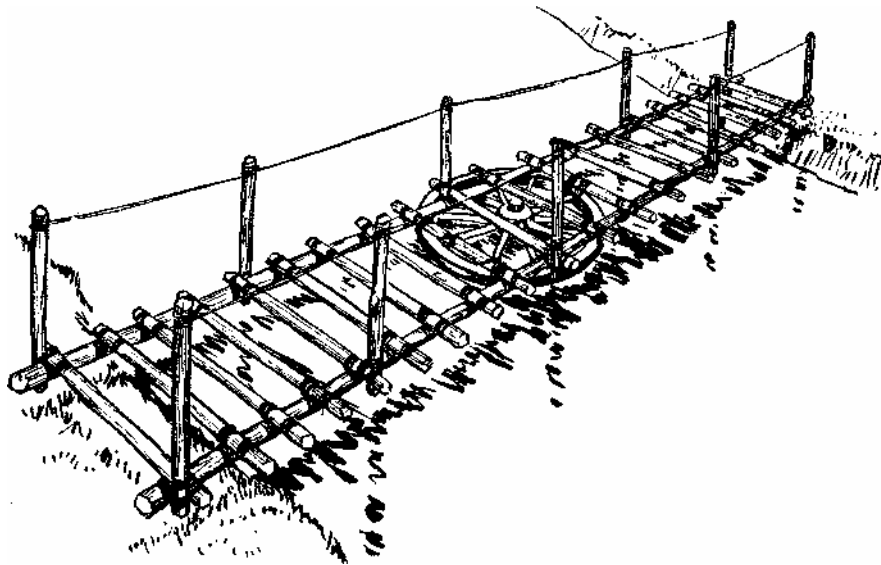

Whenever I have had a go at fixing this thing, the major problem has been fixing the wheel. The actual roadway of the bridge – the ladder part – calls for no comment because it is identical to the one we have used many times previously. There is, perhaps, this to add though, one would normally make this roadway in two parts because you don't want too long a spar. The strain gets too great or else you have to have an unduly heavy spar. So I think we will build it in two parts and lash them on to the wheel, which makes an excellent base, as I hope you have already found.

This business of fixing it into the stream or into the mud does call for quite a bit of ingenuity, and the best thing I can suggest to you – the only thing I have found feasible in practice – is to use the other half of our pair of wheels. I hope when you got your wheel you took the precaution of getting both, because if you place the other wheel, which because of its weight and its iron fittings will nestle firmly on the bottom of the stream or into the mud, well then you have something really secure, and you can add to security by piling rocks or sandbags, bags filled with whatever the material of the district happens to be, on to the top of that bottom wheel so that it stands a reasonable chance of remaining upright. Failing this, I am afraid, the only way is to drive an axle, perhaps elongated by lashing – I would

suggest four pickets – round it; to drive the whole of that as far into the bed of the stream as you possibly can. It’s a messy job, but pioneers can’t always expect to be comfortable when they are preparing the way, and so here is an occasion when you really must get down to it – or at least your Scouts must. Get their coats off, roll their shorts up and get, possibly literally, up to their necks in mud, but it’s a nice experience and one of those grand things to look back upon.

I don’t think there is any more I need say about this project because it really is a good proposition; it is workable, it is worth doing, and I hope you will have a shot at it.

Perhaps, finally, I might say what I have said so often already: this is one of those things that is going to take a little longer in practice than we might have thought from just looking at the artist’s drawing, so allow yourselves plenty of time, especially to get that wheel firmly fixed into the bed of the stream.

Chapter XXVII

PROJECT NO. 22: SAUSAGE RAFT AND CATAMARAN

GEAR REQUIRED

Spars :

Six light poles and staves.
Two 10-foot.
Two 4-foot.

Lashings:

Nine 10-foot light.
Six 10-foot.
Two 20-foot.

Oddments :

Bracken, hay, or other stuffing.
Three small tarpaulins or old canvas.
Sisal or cod-line.
Two planks 6-feet and 4-feet.
One barrel 4 feet to 5 feet high, must be sound.
Two light planks and pieces of plank for oars.

THERE are all sorts of ways of making rafts, and in this book we are going to discuss one or two of them. We are going to start with something simple. The first drawing shows a sausage raft, which is usually constructed of old ground sheets or old tarpaulins into which we pack straw or hay, almost anything that is light and will give a certain amount of rigidity when we use it. The great secret, of course, of getting these things right is to make sure they are reasonably watertight. You can best do that by being very careful of the way in which you wrap up your sausages. There is an awful snag about ground sheets and that is the eyelet holes. You have got to be quite sure they are not in vulnerable places where the water can get at them, or a very great deal of water can get in a very small hole in a short time. So that is our first point to watch.



(1) Who is going to do what?

I would like to suggest that our Scouts build rafts by working in pairs – ultimately individually, because you can't make a sausage raft to take a whole Patrol, unless you are going to have an almost endless supply of sausage, but individually you can get the whole of the Patrol waterborne in a very short time.

(2) How long have we got?

Doing it individually is about an hour's work, but a pair takes about half an hour to forty minutes.

(3) How are we going to do it?

There is really no more to say about it. A simple framework, on top and at the bottom as well for preference, just to give stability. That very careful wrapping of our grass or whatever it is we decide to use, and then to secure the sausages to the framework. There is a great deal to be said for securing each sausage individually and not trying to use a continuous lashing.

Our second raft, the catamaran, opens up all kinds of possibilities. As shown here it is clearly an individual job. An empty barrel, within reason the larger the better, and fairly secure, although a barrel if it is properly made, even if it has dried out will soon become watertight again once it gets into the water, for they are so constructed that as liquid comes into contact with them the planks of the barrel fill out and take up any cracks that may have appeared.

Give particular attention to the bung-hole: make sure that it is filled up and for preference keep it on top of the raft for very obvious reasons.

The framework should be something on the lines the artist has shown. It doesn't call for very much ingenuity to create something of this sort, and then you have a raft that is rideable by an averagely active Scout, but I hope you won't leave the catamaran at this single simple example. Obviously if you build several and marry them together you can begin to produce a very stable raft indeed. In fact, I remember one well constructed, I think, of eight separate catamarans and on to it the Scouts built a platform and put a sort of little arbour or shelter – quite a regal procession it was. Very difficult to steer, but that was quite another problem.

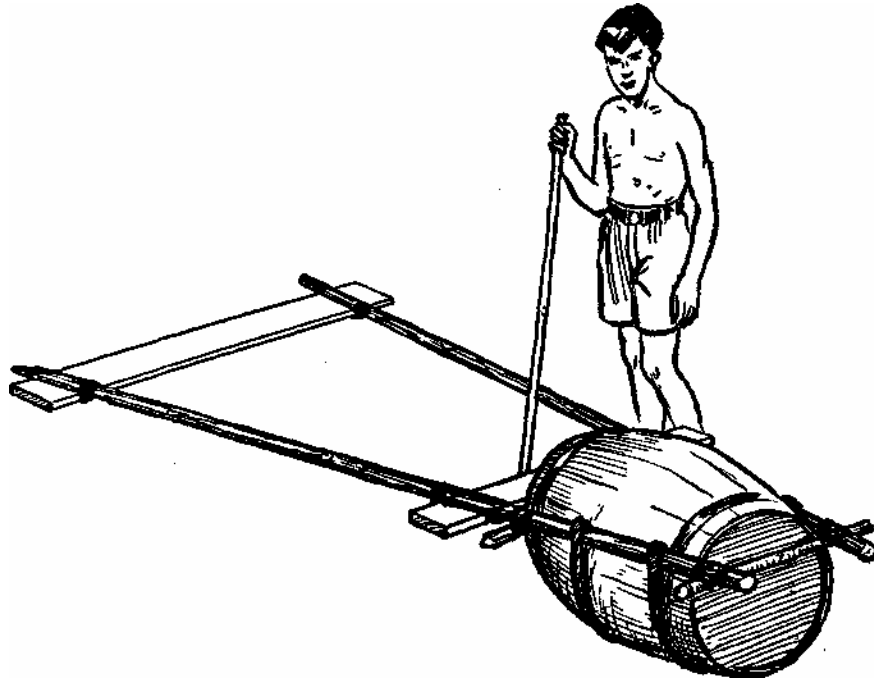

The catamaran, incidentally, in safe water can be great fun used in a surf-riding way, so I hope you will when the opportunity arises, get your Scouts working on this sort of thing. Barrels are a bit difficult to obtain, but that is your worry and I am sure you will get over it.

Chapter XXVIII

PROJECT NO. 23: THE TARPAULIN RAFT

GEAR REQUIRED

Spars:

Eight 8-foot light poles.
Eight 6-foot light poles.
Four 3-foot light poles.
One 5-foot pole for paddle.

Lashings:

Cod-line or sisal.

Oddments :

Sacking.
One tarpaulin 15 feet by
12 feet.
Plank for seat.
Board for paddle.

HERE we have something I can commend to you with every confidence that you will find it satisfactory. I can remember my Troop building one and transporting whole shoals of parents from one side of a lake to another, and we didn't lose a single Mother or

Father.

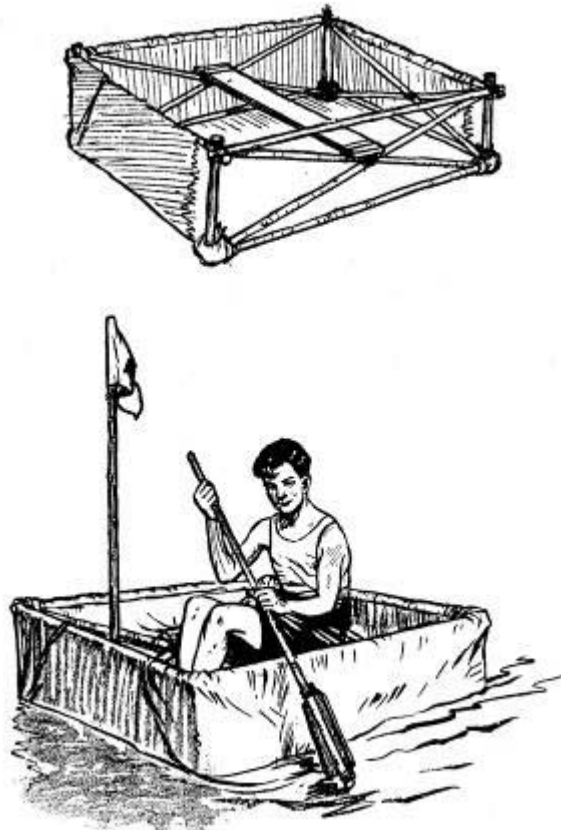

The Tarpaulin Raft.

There are a few points to consider, though I don't think we need to go right through our questions, because they don't all apply, but this sort of job tends to take rather longer than at first sight might be apparent. If you are going to make a raft to take the whole Patrol, as I hope you are (of course you will be conditioned by the size of the tarpaulin you can get), in that case I think you need to allow about an hour and a half to two hours.

Snags? There aren't really any snags, but there are possibilities of falling into error. I don't know if our Scouts are unduly pessimistic these days, but usually when I find Scouts making this tarpaulin raft, as I often do, they are allowing far too much freeboard and far too little bottom. The plain fact is that you want plenty of bottom to your raft, and 18 inches freeboard is ample. In fact, if you have too much freeboard and not enough bottom, the raft becomes top-heavy and tips over. Well, that's fine for an exhibition or water sports, but it's not much good for transportation, so broadly speaking have the bottom of your raft, that is, the bit that sits on the water, the major part of the whole show.

Before we come to our tarpaulin we must make our framework, though that must be made in strict relationship to the tarpaulin which we have.

Where can you get a tarpaulin? Well, you can buy one; they are not frightfully expensive and they have a multitude of uses; you can probably borrow one from a friendly farmer – a rick cloth is an ideal thing, and you can sometimes get cast-off railway wagon covers which are a bit heavier than we normally use, but they can be used with advantage.

Well, back to the framework. Light poles, or staves, anything fairly light, securely lashed on the lines the artist has indicated, and at every point where an upright spar comes into contact with the canvas, mask it, and mask it again. I do stress that, otherwise your tarpaulin is going to have a very short life, and incidentally to your Scouts the order of the day is “No shoes” or “Rubber shoes”. No boots or things with spikes on.

Then I think the artist might have included a few more spars across the bottom to give rigidity to the structure, to give us something to stand on.

Fix a seat in at some convenient place, make a paddle, and one day perhaps get the Scouts to carve paddles out of the solid. A pretty hefty job but it is worth doing. Finally, the Patrol flag mounted and next perhaps a sail and a rudder. Ultimately make the bows of the boat the right shape – what a non-Sea Scout would call the pointed end.

Well, there are all kinds of possibilities about this one and I hope you will go on and enjoy discovering them.

Chapter XXIX

PROJECT NO. 24: THE PADDLE STEAMER RAFT

GEAR REQUIRED

Ropes:

30-foot 1-inch for propulsion.

Spars:

Eighteen light poles 8 feet.

Or

Thirty-eight light poles 5 feet.

Three 3-foot.

Two 5-foot.

Six 6-foot.

Lashings:

Cod-line or sisal.

Oddments:

Sacking.

One tarpaulin 20 feet by
15 feet.

Plank for seat.

Four planks 4 feet by 8
inches for paddles.

Small oil drum.

Length of square timber
3 inches by 3 inches by
8 feet approx.

I THINK I ought really to call this “Paddle Steamer Raft No. 1”, because the one we are going to talk about in this chapter is the first effort that met with any success that we tried at Gilwell. Later on you will find that you can produce more advanced models. But this one is well worth building. There isn’t really very much to say about it because the boat part conforms in most respects to the raft we dealt with in an earlier chapter. But, as always, let us have a look at our questions.

(1) What have we to do?

We are going to build a raft capable of taking the whole Patrol. I think that is very important. A raft that only takes a few people breaks down the unity of the Patrol, and this is, I think, very much a matter where we are going to sink or swim together – and I hope we're going to float together. To build a self-propelled raft, then, capable of taking the whole Patrol.

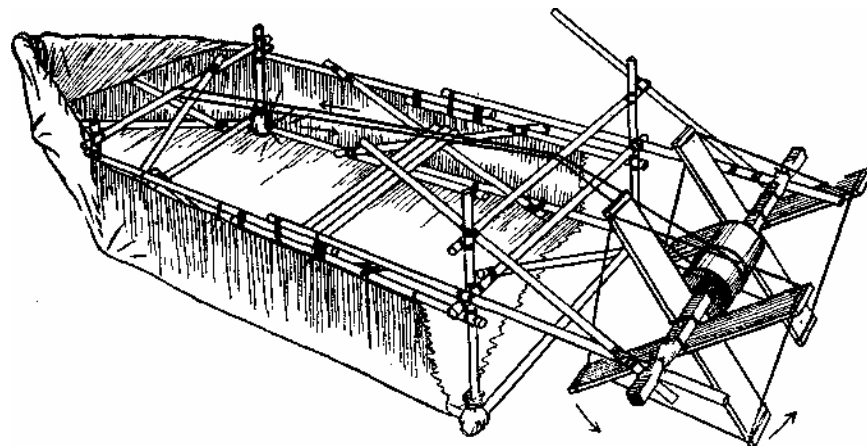

(2) What do we need to achieve it?

As usual, our Bill of Quantities is at the beginning of the chapter. You will need a very great deal of sacking.

(3) Where are we going to do it?

Somewhere near water, though the “working part” is a thing you can very legitimately prefabricate in the Troop Room, better still, I hope, in the Patrol Den.

(4) How long have we got?

This will take two and a half hours if we are going to make a proper job of it.

(5) Who is going to do what?

Here is an opportunity to invite another Patrol to join in with yours – perhaps a Patrol from another Troop. One Patrol making the business end of the raft – that is, the bit you are going to sit in – and the other Patrol making the working end – that is the paddle.

(6) How are we going to do it?

Now I am not going to deal at all with the construction of the actual raft. The drawing is clear; I hope you have already made a raft of this pattern and used it and enjoyed it, but most of the chapter will be concerned with the apparatus at the back.

There are just a few points I want to pick up before we go any farther. You will need plenty of sacking, and by plenty I mean a very great deal, so that you make quite sure all the ends of the spars are masked where they touch the canvas. And, incidentally, you want more spars – light ones (Scout staves) – across the bottom of the raft than the artist shows because you must avoid feet coming into contact with the canvas as much as you possibly can. And before you let the Patrol in do have a look at their boots. Ideally, I think, this is a bare-foot job, but if they must wear shoes, well, rubber shoes ought to be the order of the day, not great clomping things with blakeys and nails all over them.

Now for the apparatus. As I said before, it can be prefabricated. It consists of an axle which you can make out of a piece of quartering – we found quartering grips rather better than a round pole – and all you need to do is shape the two ends where they fit on the part of the structure that holds the paddle in place. Mounted on the middle of our quartering there is an old oil drum – five-gallon size is about right. You could, I suppose, use a log, but that would make it very heavy and there must be all kinds of old cans and things that are cylindrical in shape that you can get hold of – it doesn't much matter what.

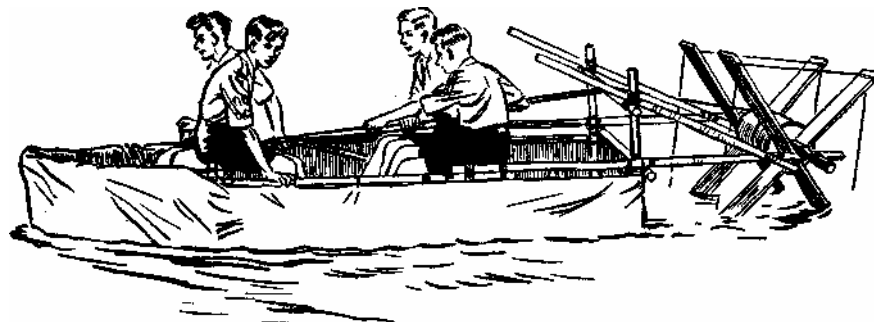

Then the paddles themselves. I know the purists are going to scream with dismay, but I hope you're not all purists, because I am going to say screw them on with good stout screws! We tried lashings, and I think the chaps that did it here were very good at lashings, but there is too much strain for the average lashing to stand up to this kind of thing. If you want to do a bit of window-dressing (and sometimes it's a good idea) screw them first and put a light lashing on afterwards. Then you have the best of both worlds, but it is the screws that will do the work and it is most important to have the paddles secure and sound so that they cannot slip adrift as soon as you get going.

Then you will notice that round the drum there is a continuous rope. That comes forward into the boat and finishes up round a spar right across the bows. In theory all you have to do is to sit down, facing forwards and pull the rope towards you and the paddles revolve behind you and along you go. And indeed in practice this is what happens, but there are snags. In the first place the artist hasn't shown us any means of steering, so as long as you want to go straight on our "Mark I" Raft is grand, but there are few places in the kinds of water we use – and I don't suggest you take this particular outfit out to sea – there are few places where we can go straight for very long. The river will wind; perhaps we have the use of a pond and we can only go round and round it; maybe a small swimming pool of some sort and there isn't much distance. All this means we must have some method by which to steer. How? Well, some of the Scouts could manipulate paddles, or you could rig up some sort of rudder with a tiller over the stern, but it gets a bit complicated and liable to get muddled up with the paddles; anyway I am going to leave that one to you to work out, for it can be worked out. But there is another snag: there comes a time when you want to go into reverse (sorry, Sea Scouts! – astern). In theory, it is perfectly easy – all you do is pull the rope the other way and you do go astern very nicely, but meanwhile, of course, the paddle is turning towards the boat and it proceeds to fill the boat with water at an alarming rate. In fact, I have never seen a neater way of committing suicide than using this raft going astern. How to get over it? Some sort of splash board, I suppose, or another piece of canvas up the back, it doesn't much matter what.

Now what else is there to say? I think just this. You do need a completely rigid structure if this raft is going to work. It means your lashings must be really impeccable, and you do need good discipline in the raft. If chaps are going to dash about from side to side; stand up – sit down; fall over; clamber overboard and get back; then anything you

are likely to make won't last long. You do really want good boat drill. An order of getting in, everybody knowing their place, everyone knowing their job. In fact, it is a grand medium for getting your Patrol literally working and pulling together.

You can improve the model I have shown you here by a mast flying your Patrol colours; you can do all sorts of things to it, but as a base on which to build I think you will have a lot of fun and some success. I made this particular raft with some Dutch Scouters a year or two back and we had grand fun dashing about in a swiftly flowing river. We didn't make a perfect job, but we made a good enough job to show that it can be done. Here at Gilwell too we have had great success with this fellow, and it might well be if you want to speed things up that here is an opportunity to invite another Patrol to join in with yours. Perhaps I ought to add this: the great secret of success in this sort of thing is getting the paddle driving just the right depth of water. If it goes in too deep you won't be able to pull it round. If it only just reaches the surface it won't drive the raft, and it is only by experiment you can get it right, because of course it depends on just how much water the raft draws when it is laden as to the exact position in which you put the paddles.

Well, I do hope you will try this one and I do hope you will have as grand fun doing it as we have had, and I hope you will improve on it and produce something of which you will be really proud. The kind of thing that will become the central feature of a Scout display, something in which you will be proud to take the Mayor – indeed the whole Corporation – around the local swimming bath.

Last of all, you may not get it quite right the first time. This is the sort of thing you must try, and try, and try again, but there's grand fun even in partial success.

Chapter XXX

PROJECT NO. 25: THE GANTRY

GEAR REQUIRED

Ropes:

Four 2-inch 30-foot guys.
Two 2-inch hawsers 25-foot
for hauling.
One 2-inch 25-foot for block
and tackle.

Spars:

Four 12-foot.
Two 15-foot.
Two 5-foot.
One 5-foot – extra stout to
be shaped.

Pickets:

Eight.

Lashings:

Ten 15-foot.
One 10-foot attaching
tackle.

Blocks:

One single.
One double.

Oddments:

Spade.
Maul.
Plank for chair seat.
Sisal for mousing.

I AM often asked by Scouters and Scouts, where do I get the ideas from? It is a little difficult to answer in most cases because they creep up on me gradually, but this one I can tell you where I got it from, and that was from an undertaker's yard that I used to pass on my way to and from school, many, many years ago. The gantry was used for moving large slabs of granite and marble from the stock-pile (I suppose they called it), until it passed through all its processes and landed out as a finished tombstone at the end.

This pioneering project has, therefore, a somewhat ghoulish origin, but is nonetheless worth while for that.

(1) What have we to do?

I think the drawing is clear enough. We have to make a bridge – we are always doing that – across a stream, and we are going to have a rather ingenious method of traversing from one side of the bridge to the other.

(2) What do we need to achieve it?

Nothing very exciting except that here I think we do need that top roller gadget prefabricated in the Troop Room, something where the carpentry experts come into their own and have a crack at making that moving piece which is very necessary. I hope it will work – I think it will, but it is up to you to make sure it does.

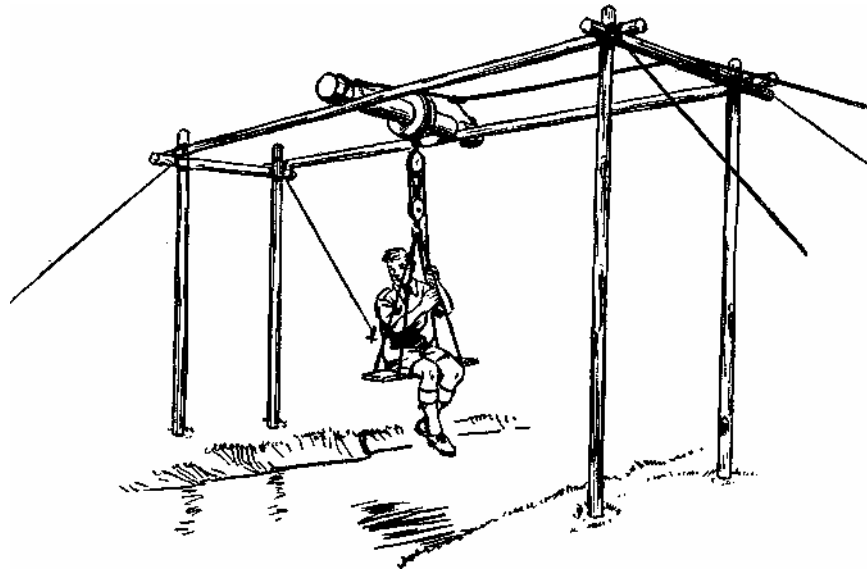

(3) Where are we going to do it?

Well, you can do this one anywhere, anywhere where you can stick the poles in the ground. You can do it without, of course. I asked the artist to keep it simple, but obviously you could put cross-braces on, guys on, have tightenings on to pickets and all the rest of it, but just for a change suppose we try to bash our poles 3 or 4 feet into the ground. Hard work, but I think it is worth a shot now and then to do it a different way. We need much less material and you can get it just as strong that way as with our more elaborate methods, the ones we have used in previous projects.

(4) How long have we got?

I haven't an idea in this case. It might take any amount of time to get it right, but the amount of lashing and the actual construction work is very little: it is getting the adjustments right and that is a matter of experience and luck. Anyway, I think you want to allow a couple of hours for a Patrol to do this, and an hour and a half for two Patrols.

(5) Who is going to do what?

Well, this one divides up all right, I think. You've poles on each side of your stream that have to be driven in and then the cross-trees to be lashed on while someone else is making the bosun's chair, and fixing it on to the slider – I think that is what we might as well call it – the working part that runs along the top of the whole bridge.

What are the snags? You'll find out soon enough – there are plenty, but I hope you will really experiment with this. I want to be quite frank with you and tell you that we have tried it, but we haven't got it quite right to our satisfaction, but near enough right to satisfy ourselves that it is a proposition, so here I do hope you will use your ingenuity. Possibly you will write in and tell me of improvements you have devised and how you have got over the difficulties of weight versus friction and all the other technicalities which you and I have to get over in practice and not on paper. I don't want to hear from anybody just on theory. I do want to hear about the snags you have found, and particularly how you have overcome them on the job in practice.

Well, do have a shot at this one. It is out of the ordinary and I have got a special affection for it because it carries me back, every time I see the drawing, to some days that are past but were grand while they lasted.

Chapter XXXI

PROJECT NO. 26: THE SIGNAL TOWER

GEAR REQUIRED

Ropes:

Half a dozen or so 1-inch guy lines (50 feet) to use as help in erecting.

Spars:

Eight 20-foot.
Four 15-foot.
Fifteen 8-foot.
Eight 6-foot.

Pickets:

Six for assistance in erecting.

Lashings:

Eight 15-foot,
Fifty 10-foot.
Cod-line for attaching the flooring and roofing.

Oddments:

One rope ladder
Light poles for flooring and roofing.
Thatching material (bracken).
Maul.

WE are getting on to a project involving a lot of work and something that I should describe as semi-permanent pioneering. The kind of thing the artist has shown us is obviously not something going to be put up and taken down in one afternoon. The kind of project for summer camp, where we want a signal tower, a look-out post, an observation post, somewhere for looking for forest fires, for looking at the stars, using a telescope, making weather reports – it has got a multitude of uses and I hope as a Troop project, for I think it is more than a Patrol project; one of these days you will build something like it. So to our questions.

(1) What have we to do?

To build a tower as high as we can make it reach. Let's really go to town over this one and be ambitious. No puny little thing about 12 feet high, but something like the artist has shown which I suppose from base to top is 24 feet high. That is the kind of thing to aim at.

(2) What do we need?

Well, we have looked at our list of gear and notice we need some very long spars, or else we shall have to join some shorter spars together. Preferably the former for this sort of thing – the sort of structure you can build on a site where timber is readily available. There are plenty of sites where that is so, though regrettably Gilwell isn't one of them.

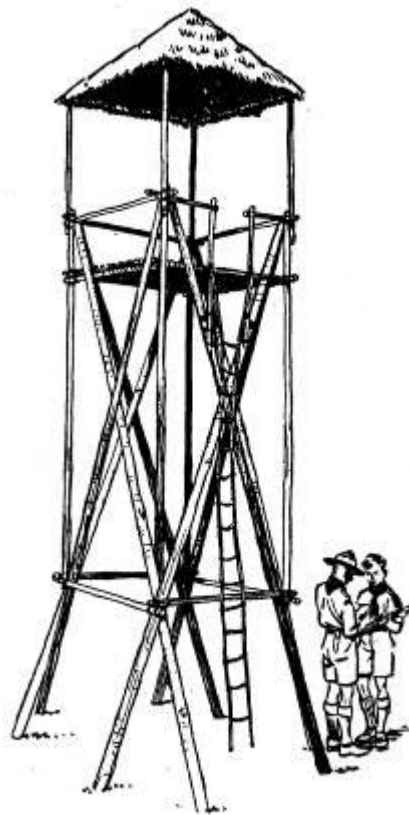

The Signal Tower.

(3) Where are we going to do it?

Well, at some strategic point, a knoll, a little hill in the camp, somewhere perhaps where we can get the look-out part just peeping above the trees and yet still concealed from anybody passing by; that is the kind of situation I would go for personally.

(4) How long have we got?

Oh, I am going to take three days over this. Don't rush it, take it easy, and do it really thoroughly and well. And if you have got your own site, or perhaps you want to build something like this near to your own Headquarters, well here again I have got to shock some of you and say you must use a few screws, not nails, but screws as well as the lashing, because if we are making a permanent structure then we do need to use permanent methods.

(5) Who is going to do what?

Well, we are all going to take a hand in this. This is going to be a Troop effort and even the youngest Tenderfoot is going to have the thrill of fixing at least one rung to the ladder.

(6) How are we going to do it?

I think that is all very obvious. There aren't any snags that I know of except the snag of getting everything we need of the right size. It is very easy to build a signal tower and find that the platform when you get on to it is sloped in such a way that you can't stand. That is bad pioneering; it is bad preparation.

A word about the thatch on top. It is not essential, but it is a good thing, especially as we are going up above the trees into the sun and right into the weather, but I've seen towers of this sort done partly roofed in and with an extended platform which you can easily work out for yourself, part of which goes outside the covering.

For the thatch: bracken, rushes, whatever happens to be available in the district you are in.

I think you will find this signal tower has immense uses, and is the kind of thing that Scouts ought to build and, having built, ought to use.

Chapter XXXII

**PROJECT NO. 27:
THE BEACON TOWER**

GEAR REQUIRED

Ropes:

Six guy lines to assist during construction.
One 2-inch 35-foot to 40-foot.

Spars:

Four 20-foot.
Eight 12-foot.
Four 10-foot.
Six 6-foot.
Thirty 6-foot light poles.
Ten 5-foot light poles.
Ten 3-foot light poles for fireplace.
Two 2-foot }
Five 2-foot } 6 inches for hatch.

Blocks:

One single sheave.

Pickets;

Six for assistance during construction.

Lashings:

Thirty-six 15-foot.
A hundred or so 10-foot cod-line.

Oddments:

Some clay for fireplace.
Brazier.
Bucket.
Rope ladder.
Two tent pegs.
Maul.

THIS tower is rather similar to the one we dealt with in the last chapter. Structurally we have used a slightly different method, but they are both easily transposable. The purpose of this is to have a beacon. It is an ideal thing for Sea Scouts who may be in camp and want to lead their boats back out of the mist at the end of the day and to help them to tie up to the right mooring. Similarly for Scouts who are playing a wide game over a large area, this could be the signal to bring them all home, in fact this could have a great variety of uses. Snags in building are the same as in the last one. Notice the differences we have made. This business of refuelling with the lift – a nice thing. Note also the door to close the hole with when the lift is not in use. That is an extraordinarily vital part of the apparatus because a lift shaft is a poor thing to fall down, even if we have built it ourselves.

As to the actual fire, the potential danger is, of course, of setting fire to the whole structure, but if you build up the kind of altar fire that the artist has shown with turf that you can keep damp, then with an old bucket holed to act as a brazier, you will have a really excellent beacon.

You might sometimes like to get the beacon even higher – that is a matter of choice, but note the way the artist has shown the prevailing wind. That is very important in the design of a thing like this. Get it so that the fire will tend to blow away from the tower and not into the centre of the tower, otherwise it becomes almost unusable.

Well, this isn't the kind of thing you can do on a Patrol weekend, but it is the kind of thing you can incorporate into your programme for summer camp, and I hope you won't

be put off by the amount of work and that you will inspire into your Scouts a desire to build this and to build it as high as they can make it reach, and having built it, use it and find all sorts of other purposes for it.

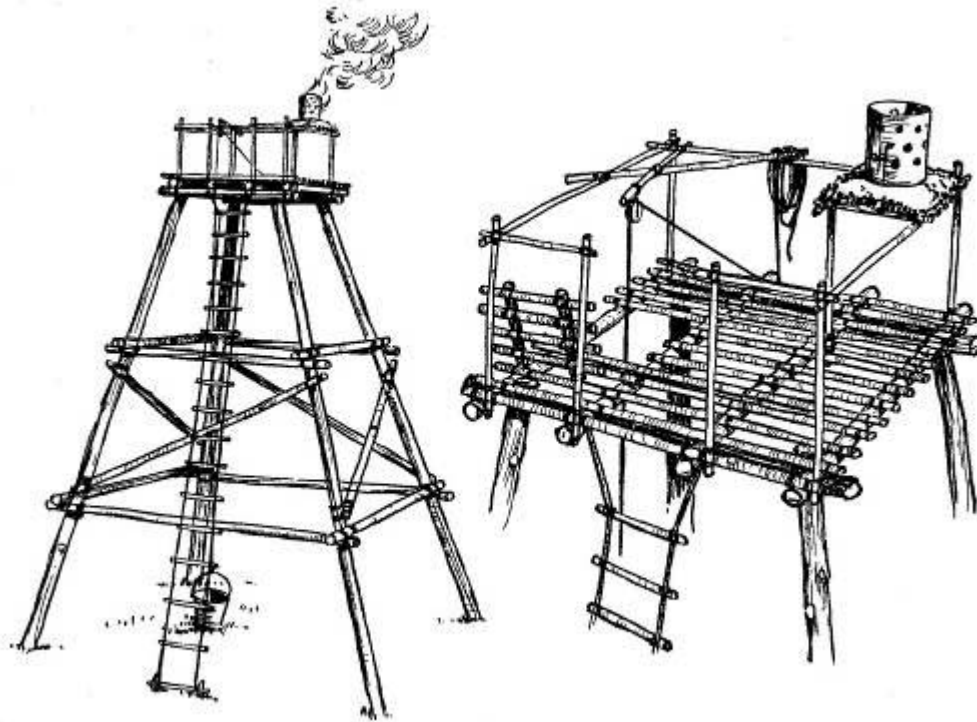

The Beacon Tower.

Just imagine, two of these across a distance of three or four miles, signalling from one to the other by flags in the daytime, using our beacon at night – the old Indian Blanket method used at all times. That is a really worthwhile experience for a worthwhile Troop, but it is up to you to find the uses; I am only pointing the way to what I think is worth doing.

Chapter XXXIII
PROJECT NO. 28:
TREE-TOP HOUSE

GEAR REQUIRED

Ropes:

One for each tackle used for raising gear.

Spars:

Twenty-four 6-foot.
Five 5-foot.
Light poles for floor and roof.

Blocks:

Luff tackles to raise the gear up tree.

Pickets:

Two small for ladder.

Lashings:

Sixty 10-foot.

Oddments:

Rope ladder.
Thatching materials.
Four prefab, sides.
Two ordinary ladders to help in construction.

I AM not really sure that this one has a place in a pioneering book, but I've put it in because I thought it was the kind of thing that those lucky enough to have a permanent site might like to try.

Let us ignore the house part for the moment and consider the platform.

(1) What have we to do?

Well, first find your tree. You must find a tree that is reasonably suitable for the project. In theory, of course, you can build a platform anywhere; so to start with, try to find a tree that has reasonably convenient branches. The one the artist has drawn is not, I think, too convenient, though he seems to have got out of it very well. I prefer a spreading type of tree; the oaks are ideal because they spread out from the centre of the bole and there is no main trunk going upwards and that leaves a space where you can build a platform.

As to building a platform, this is a fairly long job. Most of our lashings are going to be done in pretty inconvenient conditions, and it has all got to be done very, very securely indeed. This is the kind of situation where you put the extra frapping turn on and you never skip a single spot of your lashing – you really do tighten every complete round and make quite sure it is going to hold.

Now the P.L.'s job in regard to this is very important, because he is the chap who has got to see that the platform when it is finished is fairly level, and so the Patrol Leader wants to start off by marking exactly where each lashing is to be, measuring each spar, making as sure as he possibly can that the platform will be level.

As to how long it will take, well it might take a very long time indeed. My troop made something like this years ago at summer camp and on and off I think it took them the best part of five days – but were they proud of it when they finished? Did they enjoy spending the night in acute discomfort way up in the air above their fellows? Well, of course they did.

It was only a concentration of mosquitoes and other objectionable insects which finally drove them back to the ground.



Tree-Top House.

Well, now, there isn't really very much to add.

The platform – get it secure, get it level, take your time, don't rush it. When you have built your platform and perhaps another one in a tree the other side of the valley – what a grand place for signalling, or perhaps two adjacent trees, a small runway in between, and we might share delicacies at some midnight feast, or at least we can exchange visits. It opens up all sorts of possibilities. It gives a chance for the Tarzan that is in every boy really to enjoy the thrill of messing about in the tree-tops, and is well worth while.

Then if your Patrol have time, and they might well have at summer camp, and if you are in the sort of country where wood is available, perhaps you will get a chance to complete the house. The artist has made a very good job of it – he must have been where there were a lot of off-cuts, the barked edge of pine, larch, or spruce and there are many camp sites where they are in good supply. Birch would do equally well – birch cut from a thicket in places where they want it cut. You really want something reasonably straight – it's very difficult if it is all gaps and knobs.

As for the roof – a light framework from Scout staves or withy, thatched with bracken or anything that is reasonably available. Then you will have something that your Scouts will really be very proud of, something that they will remember long after they have left the Troop. These are the kinds of things that are, in my view, supremely worth while doing,

because of the memories that linger on and because of the tremendous fund of happiness that they create in the perpetrator.

So don't fight shy of this one. Do really say " One day we are going to find a camp site where we can build – no, not one, but one for each Patrol, and each is going to be better than the last! "

Chapter XXXIV

PROJECT NO. 29: A CATAPULT

GEAR REQUIRED

Ropes:

One 2-inch 50-foot for tackle.
One 2-inch 25-foot (old).
One 3-inch 100-foot (old).

Spars:

One 15-foot stout.
One 10-foot stout.
One 5-foot stout.

Pickets:

Six.

Blocks:

Two single.
One double.

Lashings:

Three 30-foot.
One 15-foot.
Seven 10-foot.

Oddments:

Two suitable trees about
10 feet apart.
Maul.
Sacking for trees.
One axe.
Large forked stick.
Small log.
Chopping block.

WELL now this really is a bit different – there's no doubt about that. I'm not going to say we have ever got it entirely right, but we have had fairly good results. We have, on one very memorable occasion, thrown an ordinary household brick 60 yards from the catapult to where it pitched, and if you ask me who wants to throw a brick 60 yards, anyway, well, we are not concerned merely with being practical, but we are concerned with enjoying ourselves and seeing our Scouts enjoying themselves. They will, I can assure you, after trying it out many times with all sorts of variations, enjoy this as much as most things we can offer.

(1) What are we going to do?

Our purpose is to throw a weight a good distance. You want a practical reason? There is one. There are occasions when you need to throw a line across a stream, Sea Scouts might even want to throw a lifeline much farther than they could without some sort of apparatus.

(2) What do we need to achieve it?

We don't need a lot of gear – the list is quite self-explanatory. May I specially draw your attention to the fact that we want some old rope and we shan't mind cutting it, because the young gentleman with the axe is obviously anxious to cut it, as often as it is brought back into place.

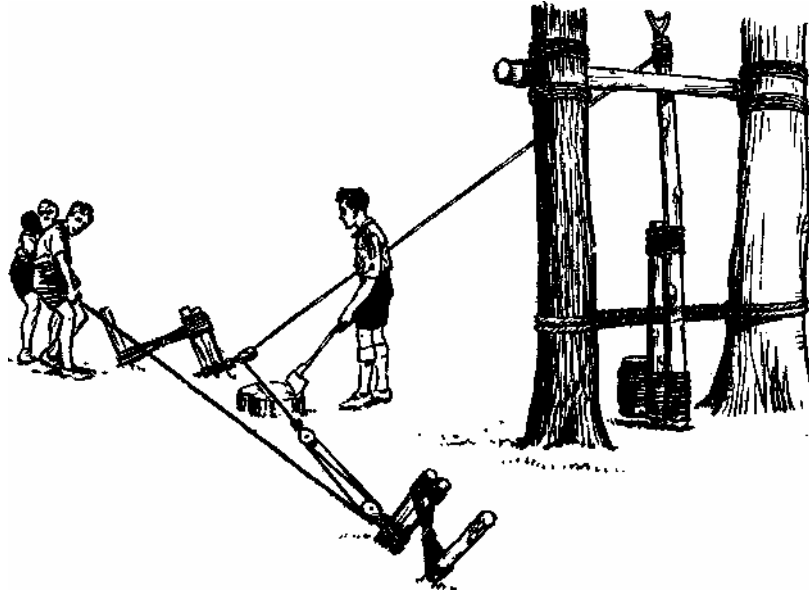

(3) Where are we going to do it?

It doesn't much matter as long as we remember two points. Firstly, we do want a couple of convenient trees about 10 feet apart. They can be much slimmer than those the artist has shown, it doesn't really matter; and we also want a clear throw, in other words you can't very well build this in the middle of a forest and hope that the brick will dodge all the intervening trees. Really you want two trees on the margin of a meadow or on the fringe of a forest.

(4) How long will it take?

An hour and a half will be plenty.

(5) Who is going to do what?

Well, there are three main things here. The catapault itself, that is, the wooden part of it. There is the structure on the tree, and there is the firing apparatus with all the pickets and blocks and tackle. Two chaps on each ought to enjoy themselves.

(6) How are we going to do it?

Divide the job up as I have suggested and decide where everything is to be – where the pickets are to be, how high up the tree we are going, and that of course is conditioned by the length of the spar of our catapault – and then get on with it. That spar fixed on to the near side of the tree needs to be lashed firmly and well. Then the rope at the bottom – that is an old rope twisted, and twisted, and twisted until we can't twist it any more. If you can't twist it tight enough by hand the best thing is to twist it on the Spanish windlass principle with a spar used as a lever. The purpose of twisting it is to make it, as it were, elastic, so that it will tend to throw the spar of our catapault when we give the word so to do.

The catapult itself? Well, one long, one medium and one short spar. The last one really a log to give it weight.

The firing apparatus, I think, you can see quite clearly from the drawing. Place the weight in the crutch of the catapult, a couple of Scouts tighten up on the pulley blocks, all stand behind the job – a fair way behind, I would suggest, for the first shot – then the word “Fire!” or “Axe!” or whatever you prefer; down comes the axe and up rushes the catapult, cracks against the spar and our weight goes in a gentle parabola to the far distance – we hope!

Chapter XXXV

GOOD LUCK!

IN Pioneering, one of the severe tests of a Patrol or Troop effort is the way in which they clear up and stow their gear. Just as in camping, one should leave a site with nothing and our thanks. The gear, before it is stored away, needs to be examined; the ropes dried, checked for any possible weaknesses that may have developed, and properly coiled. Spars should be cleaned and checked for possible fractures. Lashings should be counted, dried, and coiled. Pickets should be cleaned, checked and will probably need re-pointing. Any tools used should be cleaned, checked, and greased. Any metal parts, such as pulley blocks, should be oiled and everything should be accounted for by the P.L. before he reports back. How often have I seen Scouts build a bridge and then lose interest in it and leave the Scoutmaster to dismantle it. No job is complete until it is finished, and that means until it is cleared up and everything is accounted for, so that the Patrol has earned its Pioneering standards.

Well, there it is. Just one final word and we have done. There is a tremendous tendency to try to do the most difficult things before we are ready to do them, and I have tried in this book to put things in an order governed by simplicity of equipment and simplicity of construction so that gradually we have used more and more gear and gradually we have become more and more complicated, but if you try to start with Project No. 29, you will do two things at least. In the first place you will fail to make Project No. 29 successfully, which will mean disappointment for your Scouts and perhaps turn them against Pioneering; and secondly, even if you succeed you will have made some of the stuff in this book seem a little dull in comparison, so I hope you will take most of the steps in the pioneering ladder I have tried to build for you – not all of them perhaps, but most of them, and it should not really be beyond the capacity of a good Scout Troop to get at least one Patrol to complete the whole journey, climb step by step up the ladder and arrive triumphantly on top of the cliff, safely conveyed there by our Lifting Bridge.

And so for now that is all. It is not the end of the road, because already newer and higher rungs of the ladder are being thought out, and one day perhaps I will be able to offer more of them to you. Just for now this is where we pause and say goodbye, good luck, and may your lashings never grow weaker.

If you and I as Scouters remember that we do not build bridges for the sake of building bridges and that we are not trying to train our Scouts as Civil Engineers, but to try to develop character, we will appreciate how important is all this thoroughness, the construction and clearing away, etc. You will also learn much about your Scouts when watching them pioneer; you can learn their strengths and their weaknesses but if you build bridges yourself

and your Scouts watch, it is doubtful whether they will learn anything, either about bridge building or about anything else. So, once again, give the training in the Troop Room and leave the Patrols to get on with the job, in accordance with every page of *Scouting for Boys*.

RAFT AND AERIAL RUNWAY

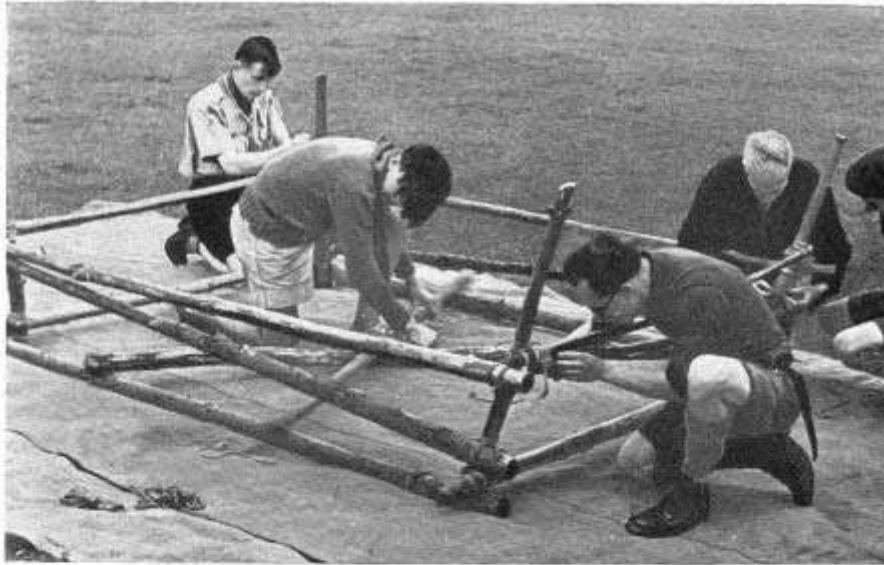

TARPAULIN RAFT UNDER CONSTRUCTION.

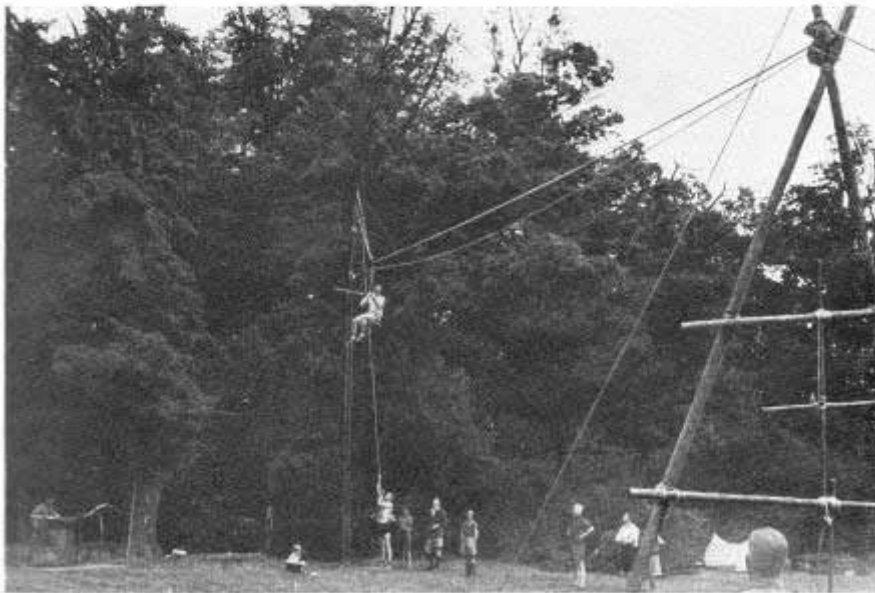

AERIAL RUNWAY IN ACTION.

LASHINGS



AN UNFRAPPED BUT
SECURE DIAGONAL
LASHING.



A NEAT YET
SIMPLE HOOK
MOUSING.

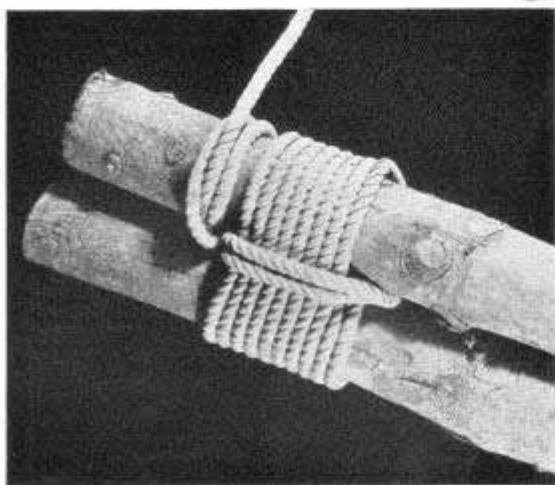

SHEER LASHING
AS FOR SHEER
LEGS.

BRIDGE BUILDING

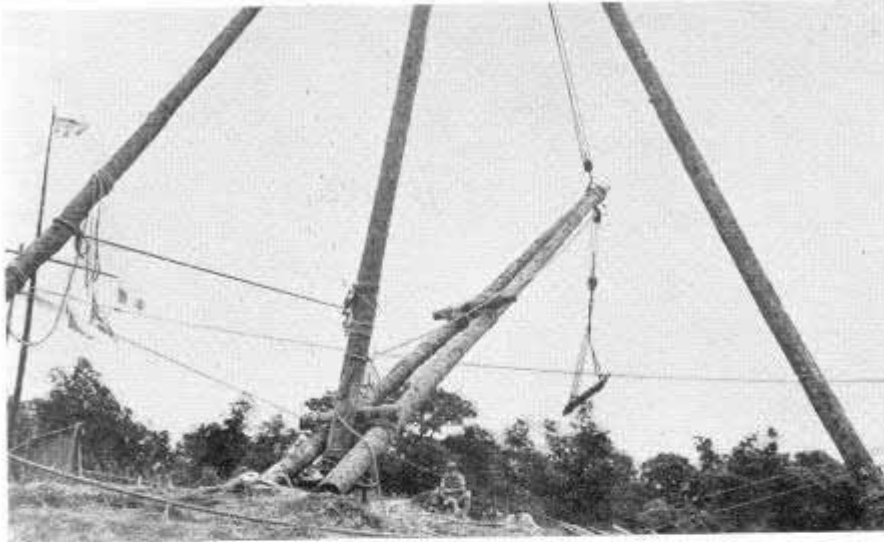

A SWINGING DERRICK.

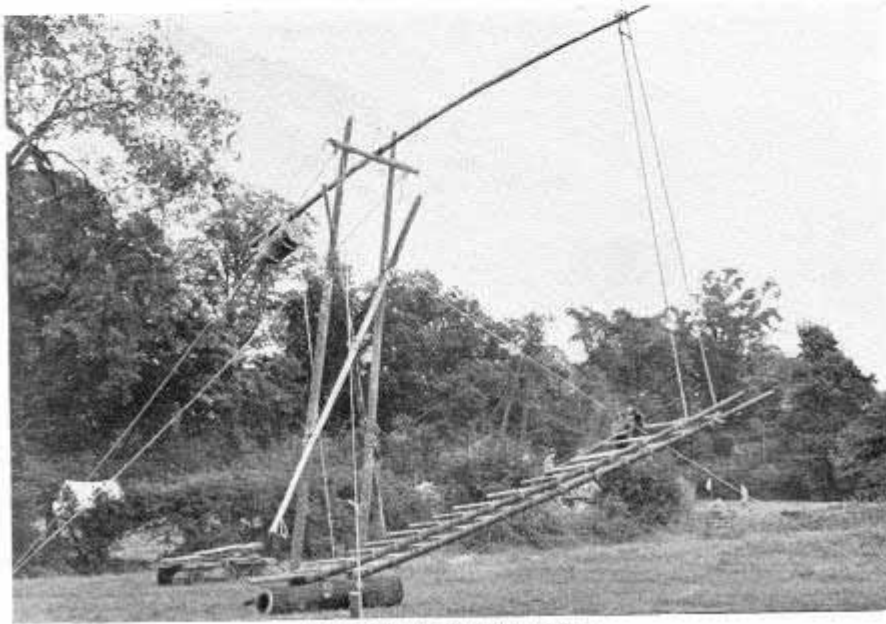

COUNTERWEIGHT BRIDGE.

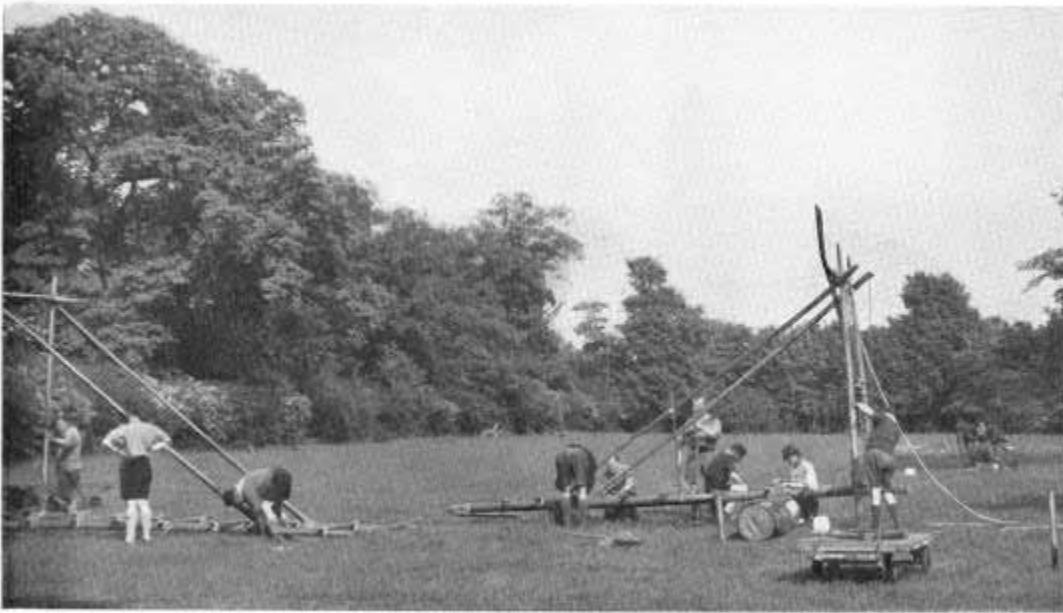

SINGLE LOCK BRIDGE NEARING COMPLETION.