

Carpentry For Boys

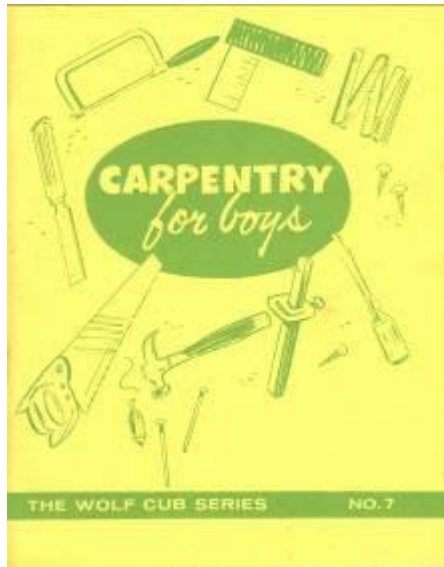

The Wolf Cub Series No. 7

(1965)

Published by
The National Council
Boy Scouts of Canada
Ottawa Ontario

Catalogue No. 20-237

Downloaded from:
“The Dump” at Scoutscan.com
<http://www.thedump.scoutscan.com/>



Editor's Note:

The reader is reminded that these texts have been written a long time ago. Consequently, they may use some terms or express sentiments which were current at the time, regardless of what we may think of them at the beginning of the 21st century. For reasons of historical accuracy they have been preserved in their original form.

If you find them offensive, we ask you to please delete this file from your system.

This and other traditional Scouting texts may be downloaded from The Dump.



The BASIC TOOLS

LET'S START BY GETTING TO KNOW OUR BASIC TOOLS. PRACTISE USING THESE TOOLS UNTIL YOU CAN HANDLE THEM WITH EASE. KEEP HANDS OUT OF THE WAY OF MOVING TOOLS AT ALL TIMES.

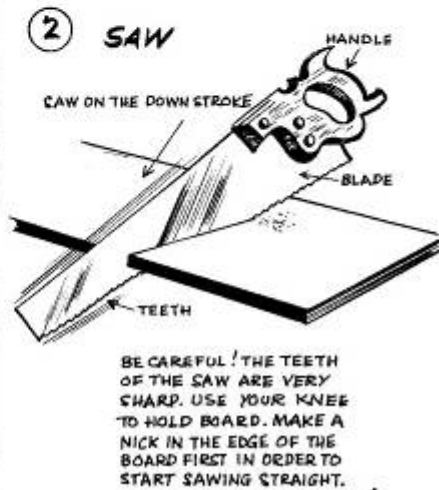

6 SCREWDRIVER

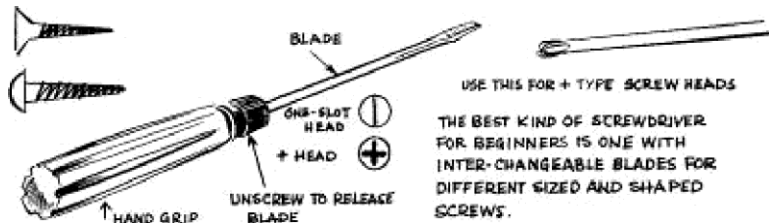

7 RULER, COMPASS



8 PENCIL, WOOD GLUE

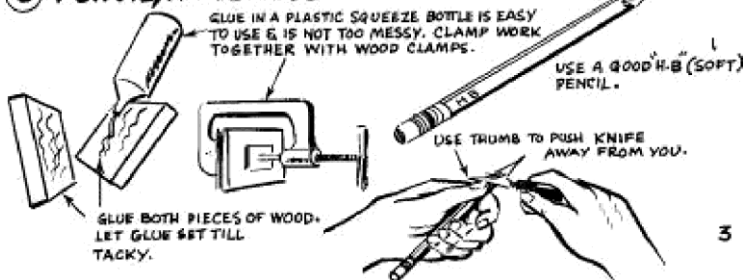

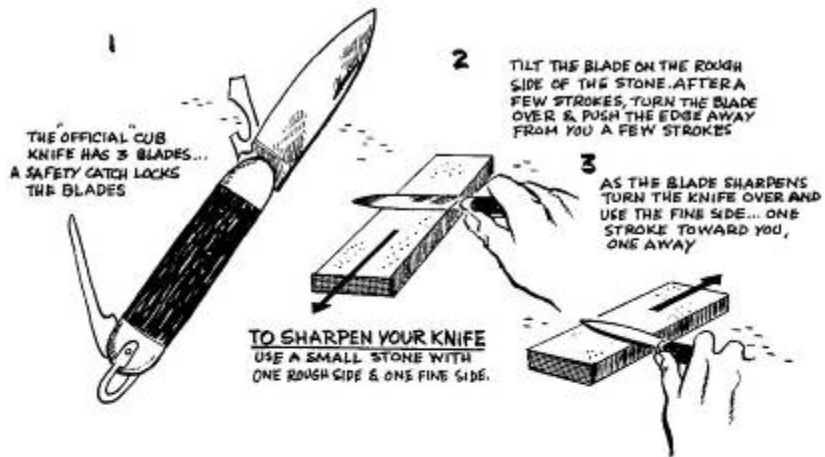

The KNIFE and its uses!

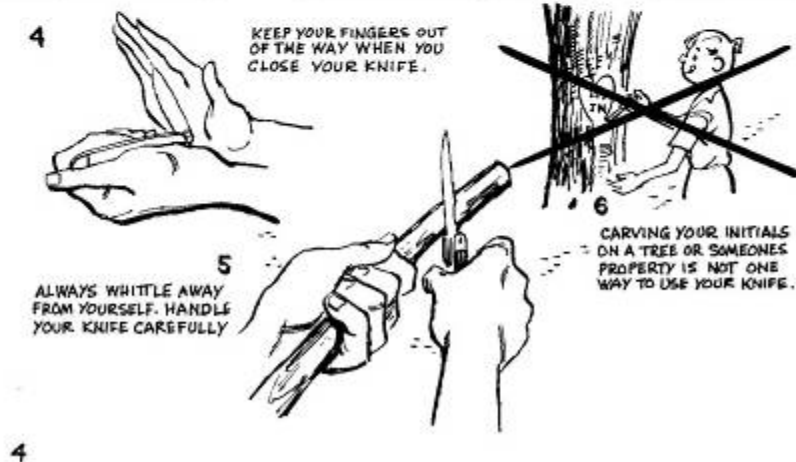



KEEPING YOUR TOOLS SHIP-SHAPE IS OF THE UTMOST IMPORTANCE. RUB TOOLS WITH AN OILY RAG BEFORE PUTTING THEM AWAY. WRAP THEM UP IN AN OILY RAG.

OILSTONE



BUY A GOOD OIL STONE FROM A HARDWARE STORE.

SHARPENING CHISELS, PLANE, ETC.

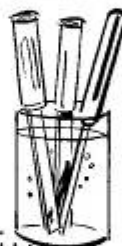
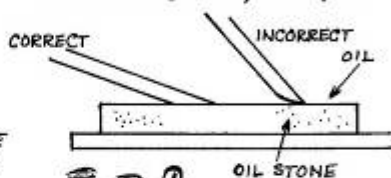

DIPPING

TO KEEP RUST AWAY DIP YOUR TOOLS IN VARSOL & WIPE CLEAN AFTER USING VARSOL.

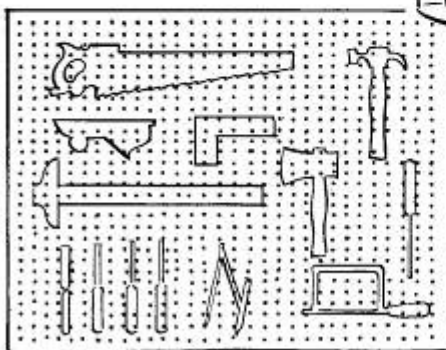

KEEP A TOOL BOARD HUNG ABOVE YOUR WORK BENCH.

WILLOW WHISTLE

(USING YOUR KNIFE)



CUT OFF A SECTION OF A STRAIGHT WILLOW BRANCH ABOUT 3 OR 4 INCHES LONG & ABOUT $\frac{1}{2}$ " IN DIAMETER. WHITTLE ONE END ON A SLANT TO FORM A MOUTHPIECE THEN NOTCH AS ILLUSTRATED. PUSH CORE OF WOOD CAREFULLY OUT OF ITS BARK SHELL

USING *your tools!*

MAGIC WINDMILL

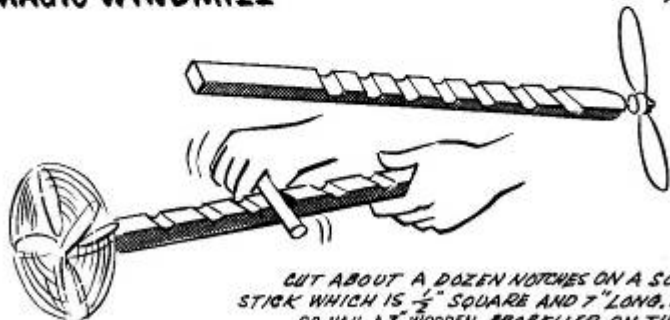

CUT ABOUT A DOZEN NOTCHES ON A SOFT WOOD STICK WHICH IS $\frac{1}{2}$ " SQUARE AND 7" LONG. PIN OR NAIL A 3" WOODEN PROPELLER ON THE END OF THE STICK. THEN RUB A PENCIL QUICKLY OVER THE NOTCHS. THE VIBRATIONS MAKE THE PROPELLER ROTATE.

PAPER KNIVES

PAPER KNIVES ARE FAIRLY SIMPLE TO WHITTLE. USE DIFFERENT WOODS, MAKING USE OF THE KNOTS, TWISTS, ETC. IN THE WOOD TO MAKE INTERESTING HEADS FOR YOUR KNIVES. PAINT IN BRIGHT COLOURS.



USE THE NATURAL SHAPE OF WOOD TO MAKE BIRD'S HEAD.

THE 3 KNIVES ON THE RIGHT ARE SHAPED FROM HARD WOOD. BIRCH, MAPLE & WALNUT ARE SUITABLE. THE WOOD SHOULD BE $\frac{3}{16}$ " THICK. → DRAW THE DESIGN ON PAPER FIRST. THEN, BY USING CARBON PAPER, → TRANSFER IT TO THE WOOD. USE A FILE TO MAKE A CUTTING EDGE.

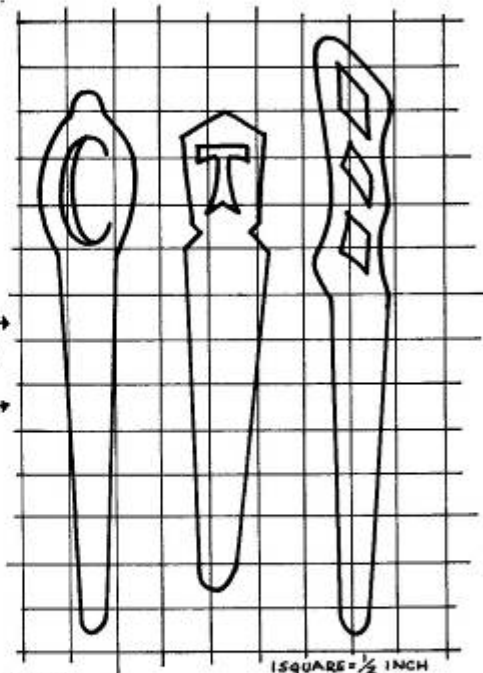

USE THE SHAPE OF THE WOOD

SELECT A PIECE OF WOOD FOR ITS COLOUR & GRAIN. SAND SMOOTH AFTER CARVING. VARNISH.



TOTEMS

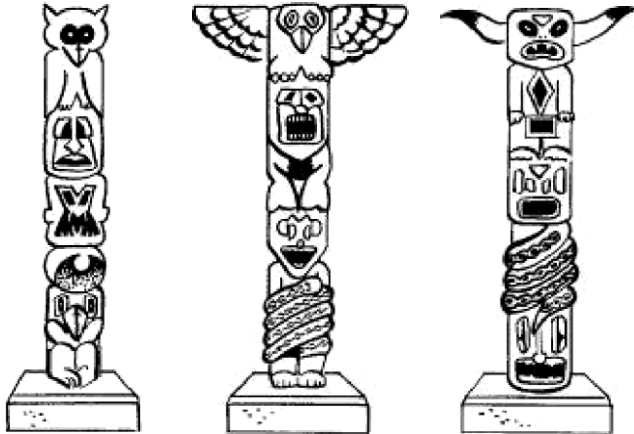

משתקן I !!! If??? MIL
 4.57 PM Fifi? WFIMW
 4539 ms rm-game SW
 "ש" רח. הזמן, "4:71.1. ונפי?
 "שגשגות. שז"/פס;
 Pa?" אפ" afffid "3451
 E mam רח-94? ג'ים
 rarmmw "???" רח/ רח
 MM my ganja? in?
 "6115671046!; mm mug)
 rm; >!!!-מ:פ: a משמש"; זמ!
 MM! "???" Alarm?
 If115 ;

משתקן I !!! If??? MIL
 4.57 PM Fifi? WFIMW
 4539 ms rm-game SW
 "ש" רח. הזמן, "4:71.1. ונפי?
 "שגשגות. שז"/פס;
 Pa?" אפ" afffid "3451

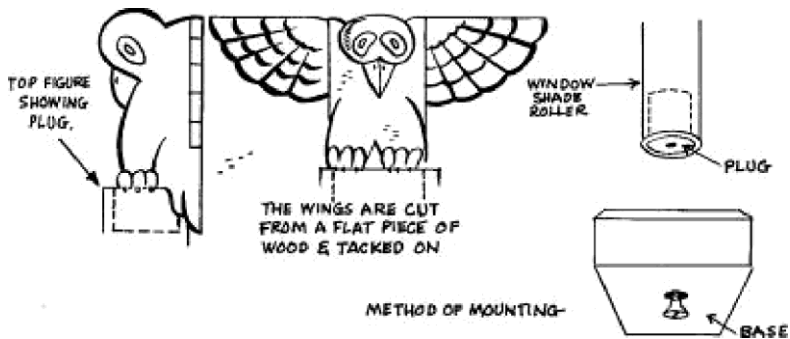

E

NECKERCHIEF SLIDES



YOU CAN SPEND MANY HAPPY HOURS WHITTLING NECKERCHIEF SLIDES FROM SOFT WOOD, SUCH AS WHITE PINE, POPLAR, WILLOW & BASS.

EARS MADE OF OLD SHOE TONGUE

A COW'S-HEAD SLIDE MADE FROM A FRUIT PIT. HORNS ARE SPURS FROM A COCK'S LEGS.

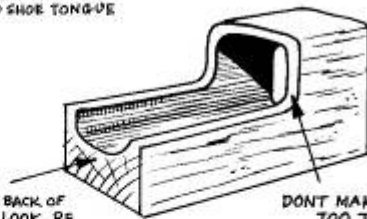

DONT MAKE WALLS TOO THIN.

THIS IS THE WAY THE BACK OF THE BLOCK SHOULD LOOK. BE SURE TO LEAVE ENOUGH WOOD FOR THE FIGURE.

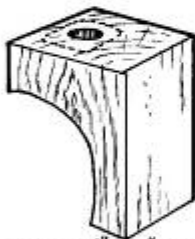

CUT OUT OF $\frac{1}{2}$ TO 2" MATERIAL, DEPENDING ON DESIGN.

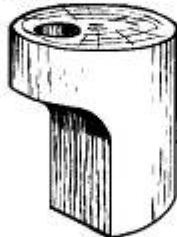

SMALL HOLES CAN BE BORED OR DRILLED FIRST, AND ENLARGED WITH A KNIFE.

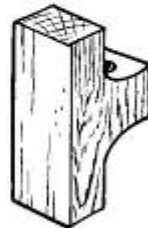

THIS SHAPE BLANK USED FOR CARVING DOLLS & TOTEM POLES.



A NECKERCHIEF MADE FROM THE VERTEBRA OF A SHEEP

FROM THE BLANKS SHOWN HERE YOU CAN WHITTLE ANY DESIGN YOU WISH. USE POSTER PAINT FOR PAINTING. FINISH WITH CLEAR SHELLAC.

HOW TO CARVE A *propeller*

THIS PROJECT IS A LITTLE TRICKIER THAN THE REST BUT ITS WELL WORTH THE EFFORT. USE A SOFT WOOD THAT YOU CAN WHITTLE. Balsa wood is popular because it is very easy to carve & yet is fairly strong.

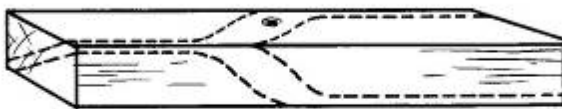

DRAW THE SHAPE ON BLOCK WITH PENCIL



PROPELLERS CAN BE SHAPED TO SUIT.

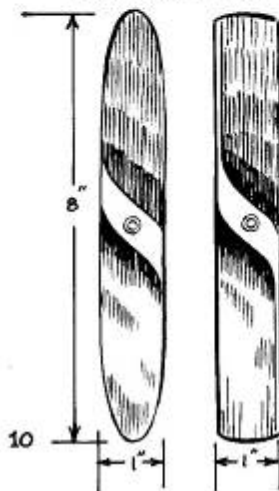

$\frac{1}{4}$ " COPPER TUBING FOR BEARINGS IN PROPELLERS & BODY. DRILL HOLE IN PROPELLER & INSERT TUBING.



ABOUT $3\frac{1}{4}$ " LONG

USE BRASS HINGE PIN ON ONE END OR USE A LONG PIN SUCH AS A LADY'S HAT PIN.

MUD MAT

(USING THE HAMMER)

THIS IS A GOOD PROJECT FOR LEARNING TO USE THE HAMMER. IT WILL ALSO KEEP THE HOUSE MUCH CLEANER. MAKE THE BASE FIRST FROM A PIECE OF HARDWOOD—BIRCH, MAPLE, ETC. LEAVE $\frac{1}{8}$ " BETWEEN CAPS. LAY OUT AS SHOWN. THE DISTANCE BETWEEN LINES IS THE DIAMETER OF CAP PLUS $\frac{1}{8}$ ".



USE POP BOTTLE CAPS WITH CRIMPED EDGE FACING UP.



USE A STRONG, WIDE, FLAT-HEADED NAIL (THE TYPE USED FOR SHINGLES)

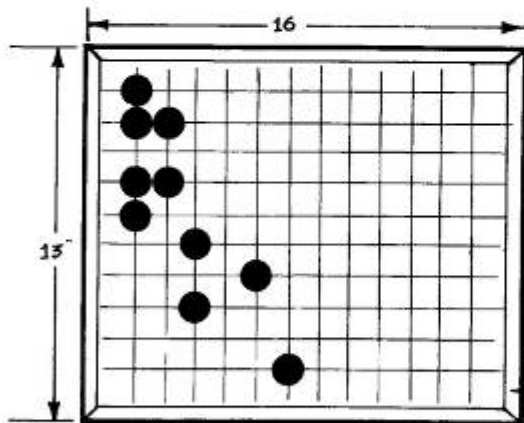

LAY OUT PENCIL LINE SQUARES. CENTRE BOTTLE CAP & NAIL INTO PLACE

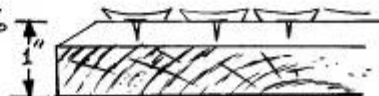

dog bed

HERE'S A SIMPLE BED FOR FIDO. USE 1" PINE IF YOU CAN GET IT BECAUSE PLYWOOD WOULD SPLIT TOO EASILY ON THE EDGES FOR THIS JOB. PAINT IT DARK GREEN. IT WILL BE A STURDIER BOX IF YOU USE WOOD SCREWS INSTEAD OF NAILS.

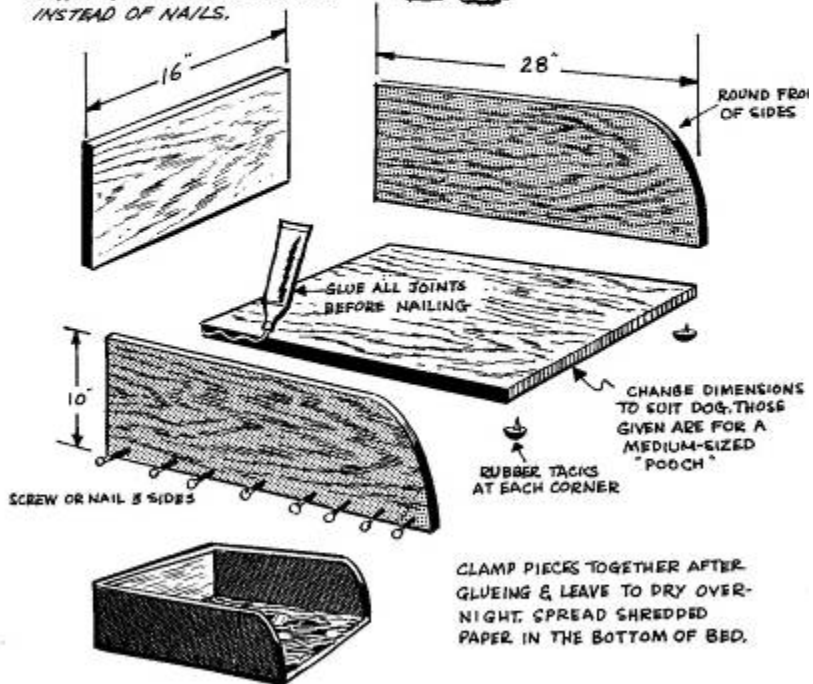

NECKTIE RACK

*THIS HANDY BACK-OF-THE-DOOR
TIE RACK WOULD BE A WELCOME
GIFT ITEM. USE SOFT WOOD,
PREFERABLY PINE, & SAND
SMOOTH ALL CORNERS AND
EDGES.*

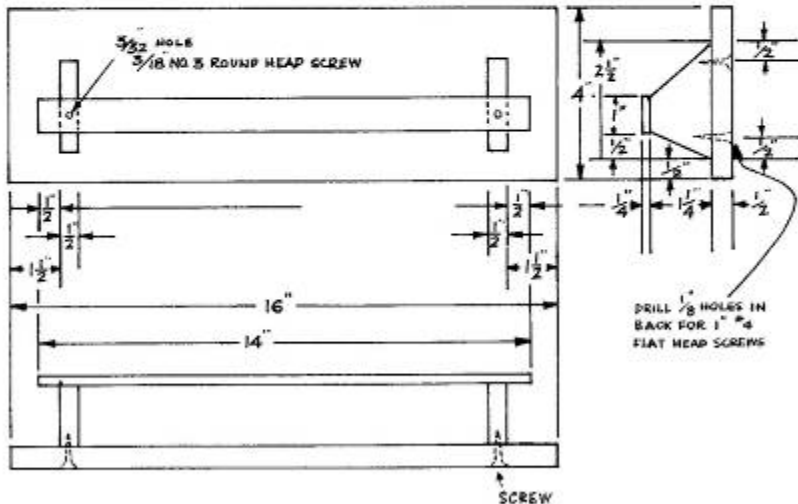

MAGAZINE Rack

*THIS WILL BE A REAL HELP
IN YOUR ROOM TO KEEP
THINGS TIDY & NEAT. THE
STRIPS ON THE BACK OF
THIS RACK SHOULD BE
ATTACHED WITH SMALL
NAILS. THE RACK MAY BE
HUNG ON A DOOR OR ON
THE WALL.*

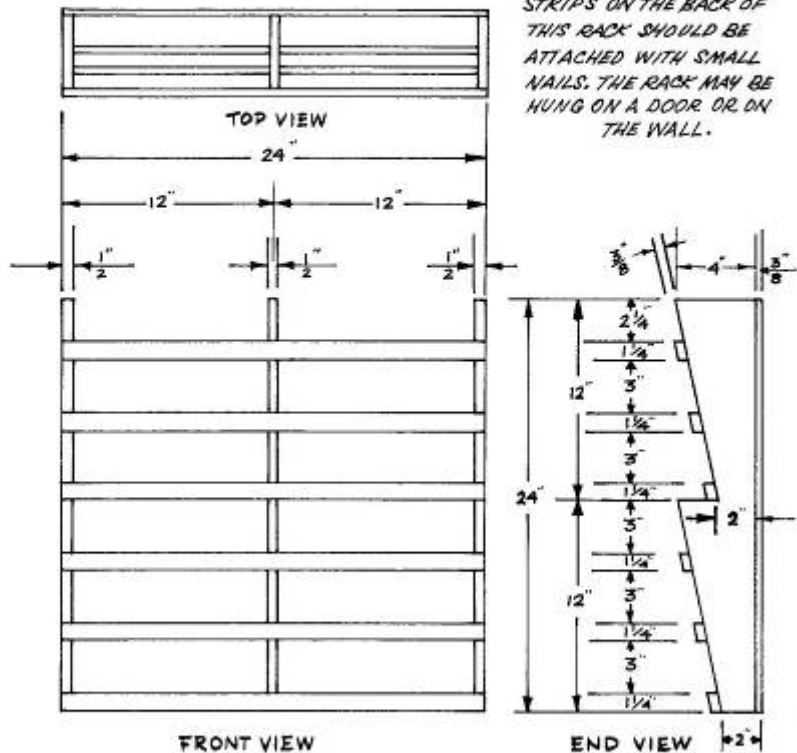

Shoeshine Box

HERE'S A SIMPLE SHOE BOX FOR YOU TO BUILD. YOU NEED $\frac{1}{4}$ ", $\frac{3}{8}$ " & $\frac{3}{4}$ " LUMBER & SOME SMALL NAILS. THE FOOT REST IS NOT NECESSARY BUT IF YOU CAN MAKE IT, IT WILL PROVE USEFUL. THE DRAWER IS JUST A PLAIN BOX, DRAWER SLIDES ON NOTCHES THAT ARE CUT INTO THE TWO SIDES. PAINT IT FIRE ENGINE RED.

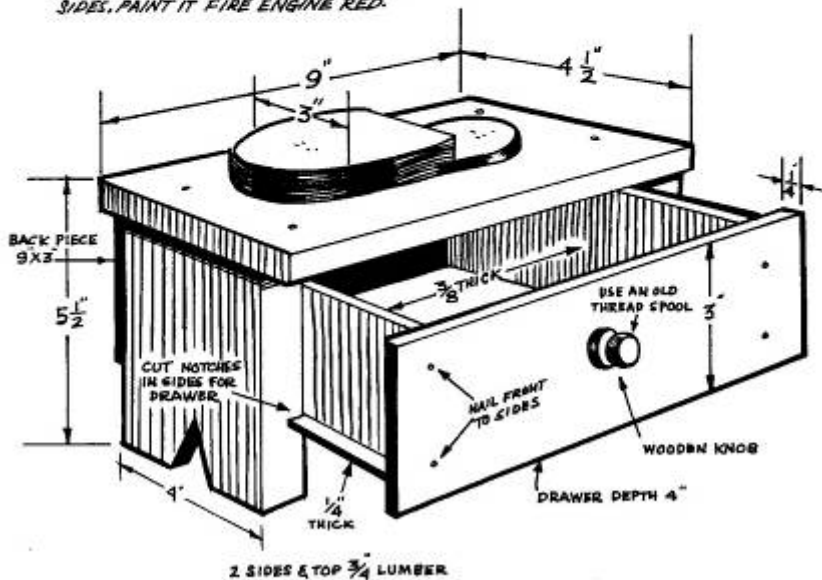

2-WAY WINDMILL

THIS WINDMILL IS MADE USING THE PROPELLER FOUND ON PAGE 10. A PIECE OF $\frac{1}{4}$ COPPER TUBING, AN OLD HINGE PIN, & A PIECE OF SCRAP ALUMINUM & A PIECE OF PINE. IT IS IMPORTANT TO DRILL THE HOLES STRAIGHT. PAINT ONE PROPELLER RED & THE OTHER BLUE

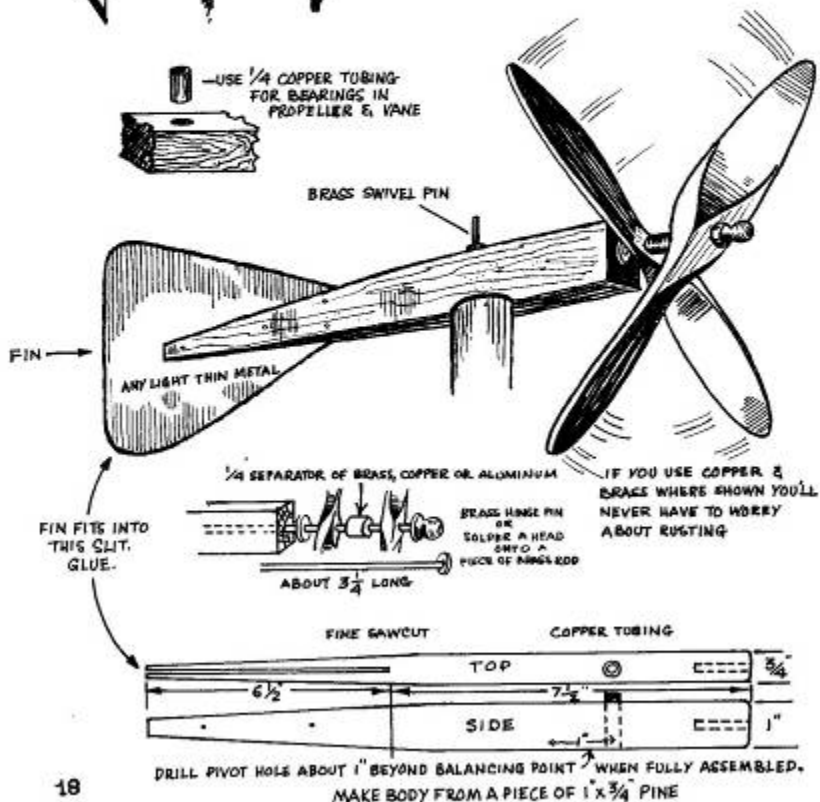

SKITTLE ALLEY

IN THIS TOY THE MISSILE IS SHOT FROM A CANNON OR A CATAPULT. THE BEDBOARD SHOULD BE ABOUT 4' LONG X 11" WIDE. A SQUARE FOOT SHOULD BE GLUED OR SCREWED TO THE UNDERPART AT EACH CORNER. USE CARDBOARD FOLDED IN TWO FOR AMMUNITION. THE SOLDIERS CAN BE MADE FROM CLOTHES PEGS. THESE WILL NEED TO BE GLUED TO A BASE.

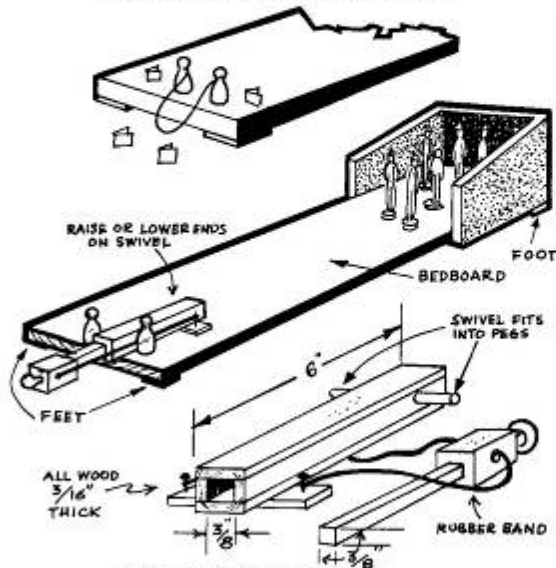

THE CANNON 4 PIECES OF THIN PLYWOOD FORM THE BARREL OF THE CANNON. MAKE THE ROD FROM ONE SOLID PIECE OF WOOD WITH A SMALL KNOB SCREWED INTO THE LARGE END.

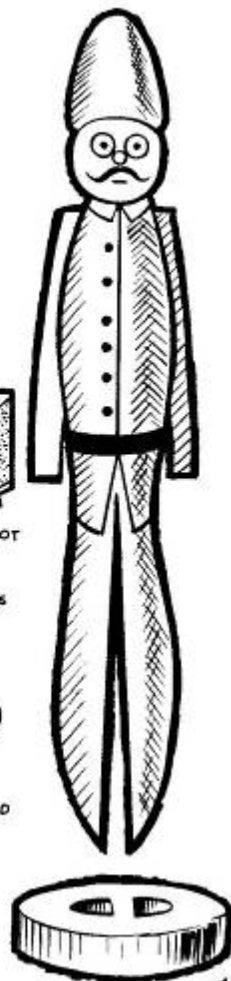

POT holder rack

AN ITEM THAT WILL FIND A WELCOME HOME IN ANY KITCHEN IS THIS POT HOLDER RACK. A COPING SAW IS USED TO CUT OUT THIS PROJECT.

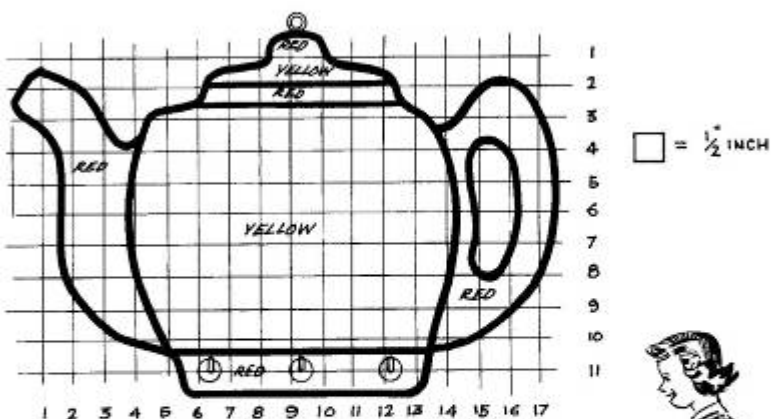

CUT WITH A COPING SAW FROM $\frac{1}{4}$ " PLYWOOD. USE FILE & SANDPAPER TO SMOOTH ALL EDGES. APPLY A FLAT COAT OF WHITE PAINT & THEN USE ENAMEL FOR THE FINISH COAT. ADD 2 OR 3 SMALL BRASS CUP HOOKS & A SMALL SCREW EYE



Periscope

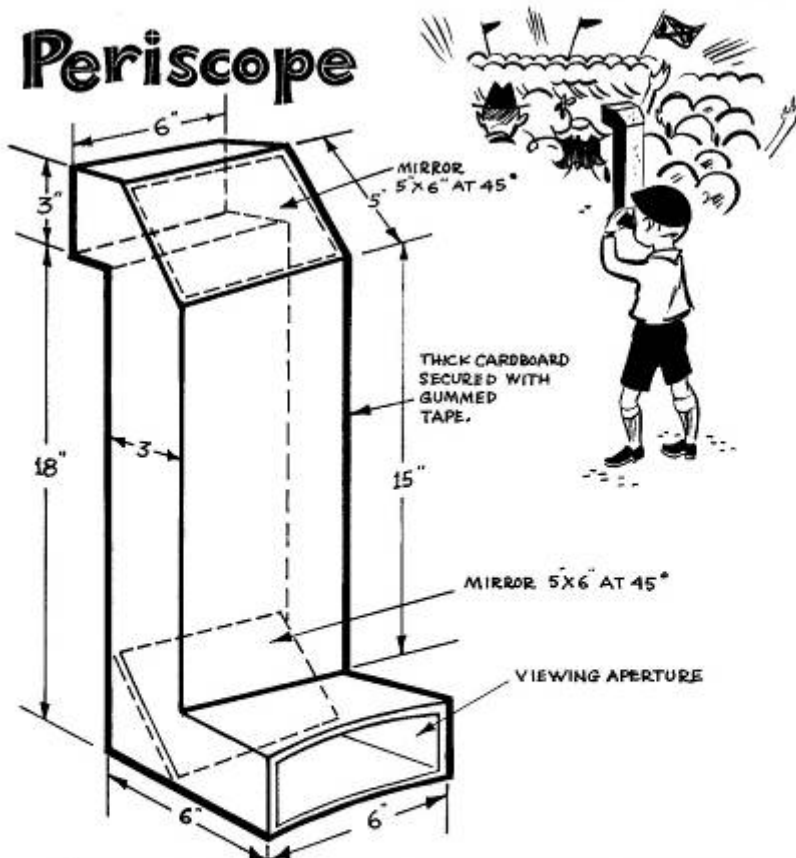

YOU WILL NEED THICK CARDBOARD, TWO MIRRORS 5x6" & A ROLL OF 1 GUMMED PAPER. CUT OUT 2 SIDES, FRONT, BACK & BOTTOM, PAINT THE INSIDE WITH BLACK PAINT. JOIN PIECES TOGETHER USING THE GUMMED PAPER. GUM THE JOINTS ON BOTH SIDES. LEAVE

THE BOTTOM SECTION TILL LAST. NOW INSERT TOP & BOTTOM MIRRORS. ADJUST MIRRORS TO PROPER ANGLE, THEN GUM INTO PLACE. GUM BOTTOM PIECE INTO PLACE. CUT OUT HEADREST, SO THAT IT WILL FIT SNUGLY AGAINST YOUR EYES. PAINT THE OUTSIDE WITH ENAMEL.

SPICERACK

*MOTHER WILL LOVE THIS.
DIMENSIONS ARE GIVEN BUT
YOU CAN CHANGE THESE TO SUIT
HER SPICE JARS. BUILD FROM
PINE & SAND SMOOTH ALL
FINISHED PARTS. SHELLAC OR VARNISH.*

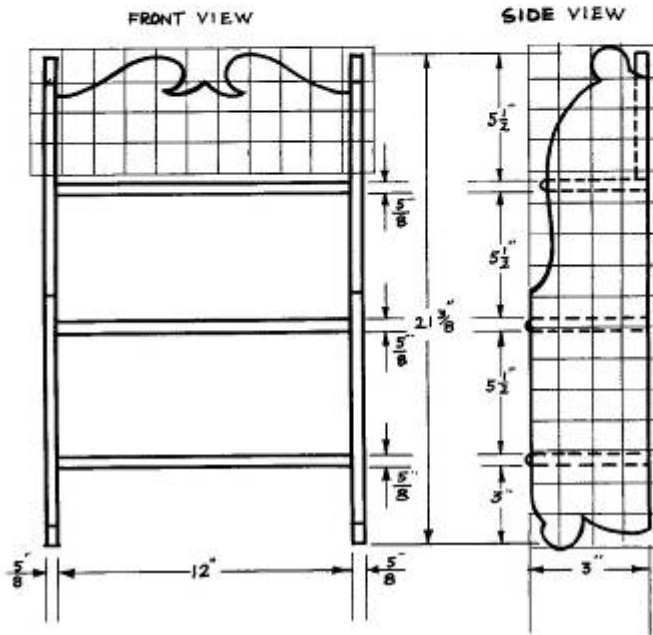

BOOK TROUGH



TRACE DIAGRAM OF BOOK-
ENDS ONTO $\frac{3}{8}$ " BOARD OR
PLYWOOD. SHELVES MAY
BE CUT ACCORDING TO
MEASUREMENTS WITH-
OUT TRACING. TO ASSEMBLE,
INSERT "A" THROUGH "B";
PUSH IN PEGS. SANDPAPER
ALL EDGES. PAINT OR STAIN.

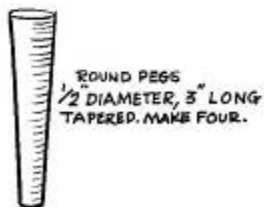
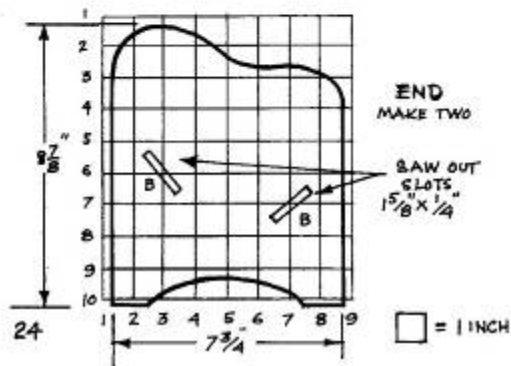
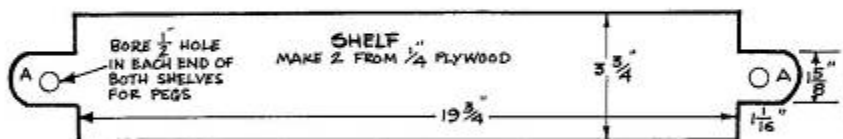

WASTE PAPER BASKET

USE $\frac{1}{4}$ " PLYWOOD FOR ALL PARTS (5). NOTCHES MUST BE $\frac{1}{4}$ " WIDE & DEEP TO FIT PROPERLY. TO ASSEMBLE- FIT "A" NOTCH INTO "B" NOTCH. THEN PUSH UP UNTIL "C" FITS INTO "D". SPREAD SIDES UNTIL "D" FITS INTO "E". STEP OFF. WHEN ALL SIDES ARE FITTED TOGETHER FORCE IN BOTTOM FROM TOP.

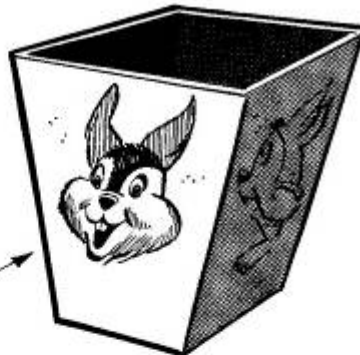

STAIN OR VARNISH OR PAINT WHITE. DECAL TRANSFERS MAY BE USED ON SIDES.

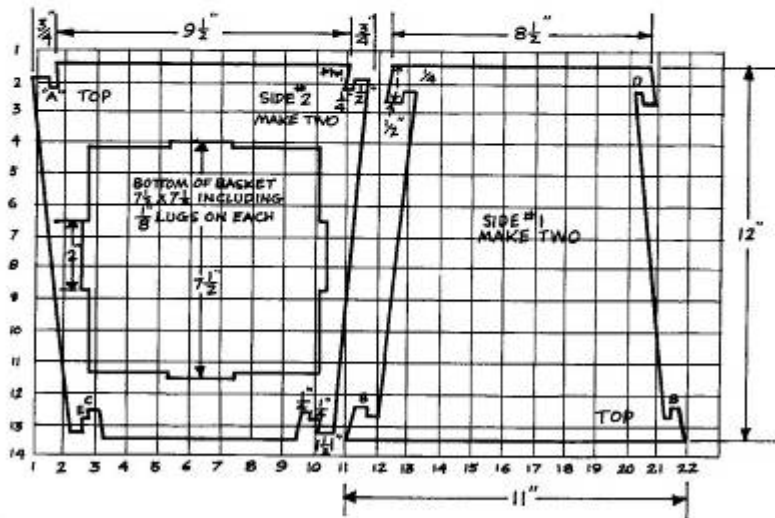

SCOOTER

FOR A SKATE SCOOTER, YOU NEED A WOODEN BOX, A FOOT BOARD, A SKATE & A HANDLE BAR. ASSEMBLE AS SHOWN. ZOOM, YOU'RE OFF.

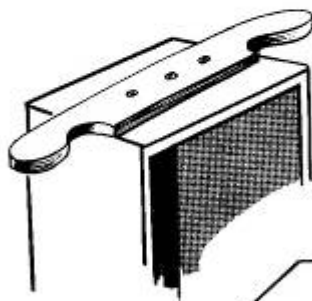

CUT HANDLE BAR FROM 1 INCH LUMBER. SCREW TO TOP OF BOX IF YOU CANT FIND A READY MADE BOX GET DAD TO HELP MAKE A SIMPLE ONE.

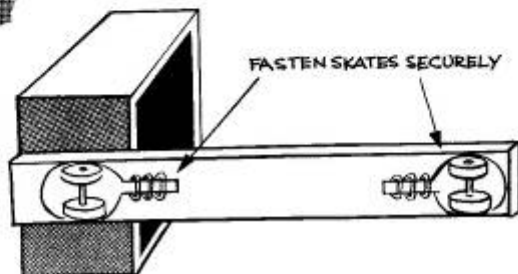

Carpentry For Boys

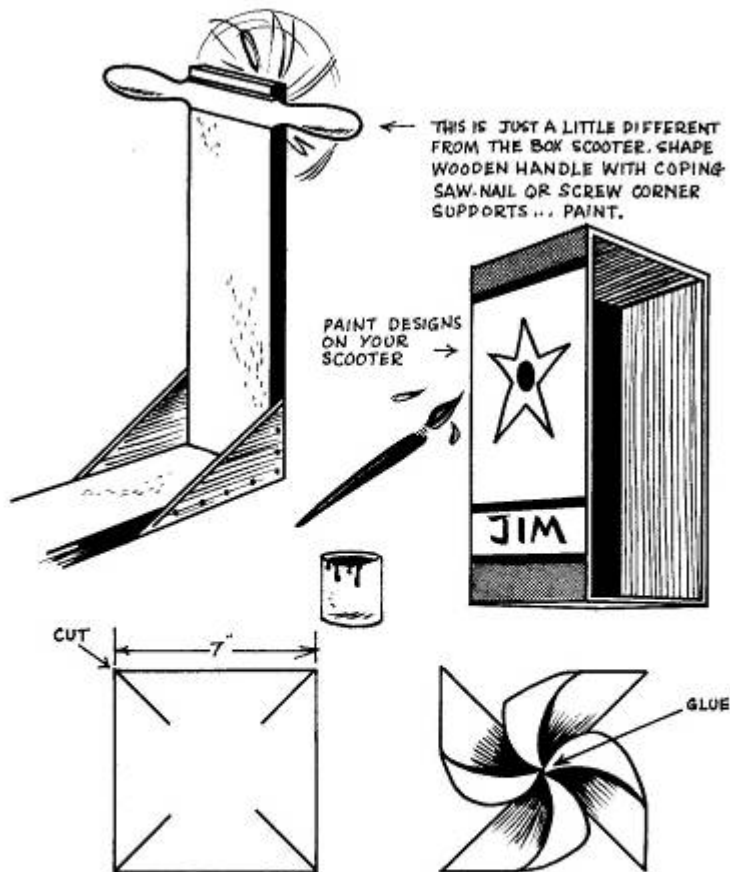

MAKE THIS WINDMILL OUT OF PLASTIC, OR STRONG PAPER. NAIL IT TO THE FRONT OF

YOUR SCOOTER. PUT A BEAD BETWEEN WINDMILL AND SCOOTER TO ACT AS WASHER TO KEEP WINDMILL AWAY FROM SCOOTER SO IT CAN TURN.

Soap-box DERBY

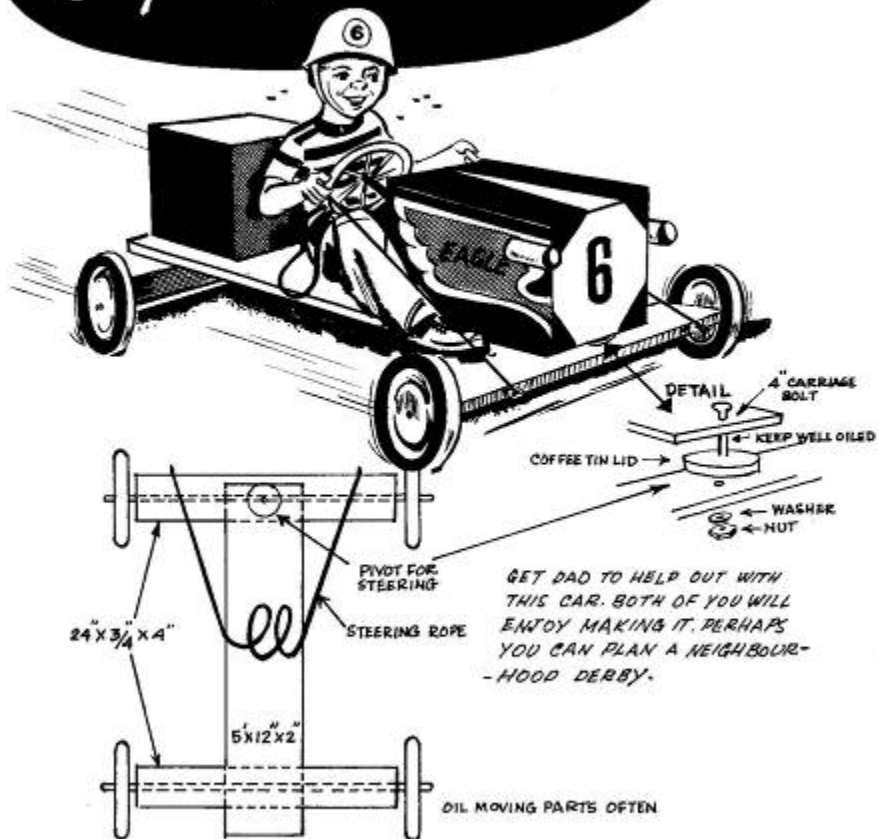

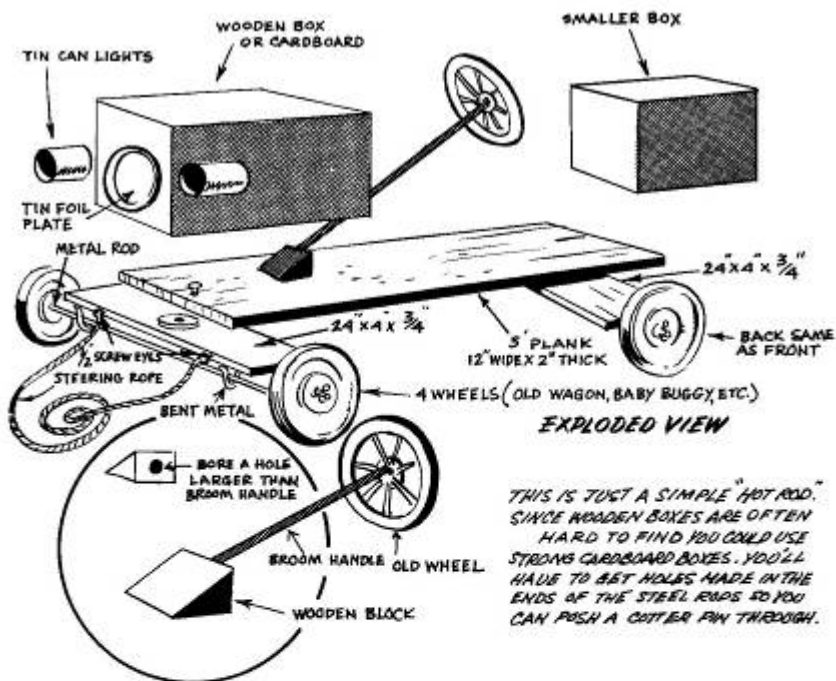

PAINT FRONT BOX LIKE THIS OR USE YOUR OWN DESIGN.



FINISHING

(SANDING, STAINING, VARNISHING, PAINTING)

THE WAY YOU FINISH YOUR WORK IS VERY IMPORTANT. A LITTLE EXTRA SANDING CAN MAKE A GREAT DEAL OF DIFFERENCE.

SUGGESTED HERE ARE THE MOST POPULAR METHODS OF FINISHING.

MAKE A SANDING BLOCK



MAKE A BLOCK ROUGHLY 3" X 4" TO FIT IN YOUR HAND. FOLD SANDPAPER AROUND THE BLOCK.



A SHEET OF SANDPAPER WILL PROBABLY BE LARGE ENOUGH TO COVER 4 SANDING BLOCKS.

SAND WITH THE GRAIN

RUB IN SHORT STEADY MOVEMENTS BACK & FORTH.



CURVED SURFACES

HOLD SANDPAPER AS SHOWN. SHAPE HAND TO FIT CURVES.

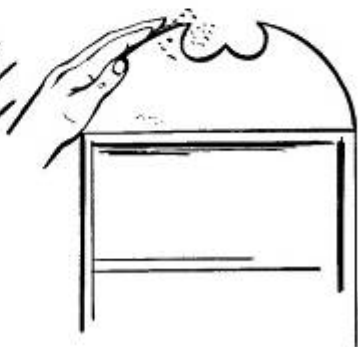

Carpentry For Boys

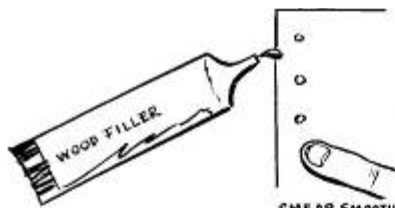

FILL ALL NAIL HOLES

YOU CAN BUY WOOD FILLER IN TUBES OR MAKE YOUR OWN BY MIXING WOOD GLUE & FINE SAWDUST TOGETHER TO THE CONSISTENCY OF PUTTY. USE IMMEDIATELY

SMEAR SMOOTH WITH FINGER.

TO STAIN...



WOODWORK IS STAINED TO IMPROVE ITS NATURAL COLOUR. YOU CAN STILL SEE THE NATURAL GRAIN OF THE WOOD. STAINS MAY HAVE AN OIL OR A WATER BASE AND COME IN MANY SHADES & COLOURS.

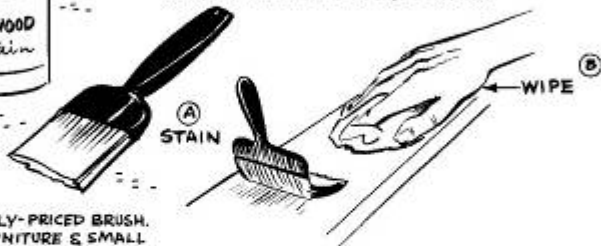

BUY A MODERATELY-PRICED BRUSH. FOR MOST FURNITURE & SMALL PROJECTS USE A SMALL SIZE. RUB OFF EXCESS STAIN WITH CLEAN RAG

